

# Hydro 2000 S

Ⓒ Installation and operating instructions

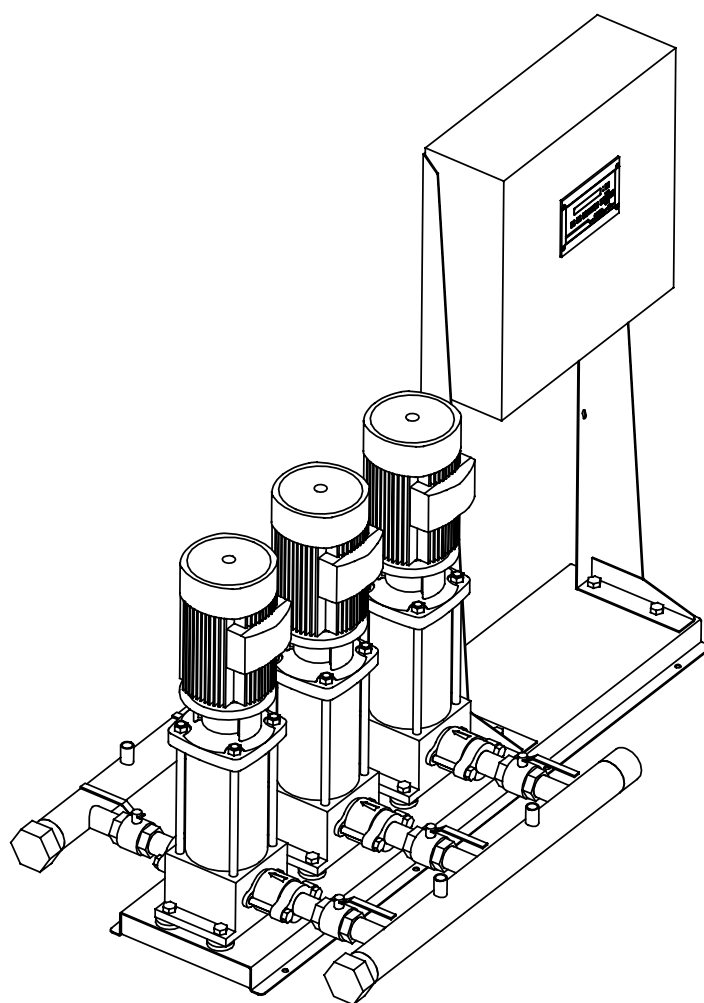

# Declaration of Conformity

We **GRUNDFOS** declare under our sole responsibility that the products **Hydro 2000 S**, to which this declaration relates, are in conformity with the Council Directives on the approximation of the laws of the EEC Member States relating to:

- Machinery (98/37/EEC).  
Standard used: EN 292.
- Electromagnetic compatibility (89/336/EEC).  
Standards used: EN 61 000-6-2 and EN 61 000-6-3.
- Electrical equipment designed for use within certain voltage limits (73/23/EEC).  
Standard used: EN 60 204-1.

Bjerringbro, 15th November 2001

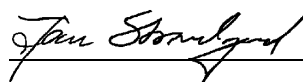

Jan Strandgaard  
Technical Manager

# CONTENTS

	Page		
<b>1. General</b>	<b>5</b>	<b>6. Operation</b>	<b>22</b>
1.1 Scope of these Instructions	5	6.1 Operation of PMU 2000	22
1.2 Related Documents	5	6.1.1 Display Rules	23
<b>2. Product Description</b>	<b>5</b>	6.1.2 Status Display	23
2.1 GRUNDFOS Hydro 2000 S	5	6.2 Configuration of the PFU 2000	23
2.2 GRUNDFOS Control 2000 S	6	6.2.1 PFU 2000 DIP Switch Settings	24
2.2.1 Examples of Booster Sets Hydro 2000 S	7	6.2.2 Configuration of PCU Relays	25
<b>3. Functions</b>	<b>8</b>	<b>7. Monitoring Functions</b>	<b>25</b>
3.1 Control Functions and Settings	8	7.1 Faults, General	25
3.1.1 Monitoring Functions	8	7.2 Pump- and Motor-Related Faults	26
3.1.2 PFU 2000 RAM Settings	8	7.2.1 Communication Faults	26
3.1.3 Closed-Loop Control	9	7.2.2 Motor Overtemperature	26
3.1.4 Cascade Control	9	7.3 Zone-Related Faults	26
3.1.5 Manual On/Off and Setting to Max. or Local	10	7.3.1 Transmitter Fault	26
3.1.6 Water Shortage Monitoring	10	7.3.2 Water Shortage	26
3.1.7 Automatic Pump Change	11	7.3.3 Maximum Limit of Actual Value	26
3.1.8 Test Run	11	7.3.4 Minimum Limit of Actual Value	26
3.1.9 Clock Functions	11	7.3.5 Any Fault in the Zone	26
3.1.10 Standby Pumps	11	7.3.6 Fault in Any Motor	26
3.1.11 Reduced Operation	12	7.4 System-Related Faults	26
3.1.12 Pump Priority	12	7.4.1 Voltage Drop	26
3.1.13 GRUNDFOS BUS	12	<b>8. Maintenance</b>	<b>27</b>
3.2 Control Parameters	13	8.1 Maintenance of Booster Set	27
3.2.1 Allocation of Pumps to Zone	13	8.1.1 Pumps	27
3.2.2 Zone Type / Control Parameter	13	8.1.2 Motor Bearings	27
3.2.3 Priority of Settings	13	8.1.3 Frost Protection	27
3.2.4 Setpoint	14	8.2 Maintenance of the Control 2000 S	27
3.2.5 Setpoint Influences	14	<b>9. Operating and Fault Indications</b>	<b>28</b>
3.2.6 On/Off Band	15	<b>10. Fault Finding Chart</b>	<b>29</b>
3.2.7 Measuring Unit for Control Value	16	<b>11. Technical Data</b>	<b>30</b>
3.2.8 System Time	16	11.1 Hydraulic Data	30
3.2.9 Minimum Switching Sequence	16	11.2 Operating Conditions	30
3.2.10 Medium Switching Sequence	16	11.3 Sound Pressure Level	30
3.2.11 Control Function	17	11.4 Electrical Data	31
3.2.12 PFU 2000 Analog Input 1 Configuration	17	<b>12. Glossary</b>	<b>32</b>
3.2.13 PFU 2000 Analog Input 2 Configuration	17	<b>13. Display Overviews</b>	<b>33</b>
3.2.14 PFU 2000 Analog Input 3 Configuration	17		
3.2.15 PFU 2000 Input 4 Configuration	18		
3.2.16 Ramp Time	18		
3.2.17 Minimum Pump Speed Limit	19		
3.2.18 Maximum Limit (Overpressure)	19		
3.2.19 Minimum Limit	19		
3.2.20 Operation at Minimum Limit	19		
3.2.21 Minimum Pre-Pressure	19		
3.3 Pump Parameters	19		
3.3.1 Maximum Head	20		
3.3.2 Operating Hours	20		
3.3.3 Start Time	20		
<b>4. Installation</b>	<b>20</b>		
4.1 Location	20		
4.2 Hydraulic Installation	20		
4.3 Electrical Connection	20		
<b>5. Start-Up</b>	<b>21</b>		
5.1 Hydro 2000 S without a PMU 2000	21		
5.1.1 Setting via a Temporarily Connected PMU 2000	21		
5.2 Hydro 2000 S with a PMU 2000	21		
5.3 Direction of Rotation	21		
5.4 Taking out of Operation	22		



# 1. General

## 1.1 Scope of these Instructions

These Installation and Operating Instructions apply to GRUNDFOS booster sets Hydro 2000 S.

GRUNDFOS booster sets Hydro 2000 S are designed for the transfer and pressure boosting of clean water in waterworks, blocks of flats, hotels, industry, hospitals, schools, etc.

The Hydro 2000 S range includes two types of systems, i.e. MS and MSH.

System Type		System Function
Hydro 2000 S	MS	All pumps are full-size pumps which are mains-operated (on/off).
	MSH	One half-size pump. The other pumps are full-size pumps. All pumps are mains-operated (on/off).

## 1.2 Related Documents

For some booster sets, the detailed information can be found in the related documents.

- List of Control Parameters (factory configuration).
- Wiring diagram.
- Installation and Operating Instructions.
- Data booklet.

# 2. Product Description

## 2.1 GRUNDFOS Hydro 2000 S

GRUNDFOS booster sets Hydro 2000 S consist of a number of pumps with all necessary fittings and a GRUNDFOS Control 2000 S mounted on a common base frame, all ready for installation.

A diaphragm tank must be included in the installation.

Fig. 1

GRUNDFOS Booster Set Hydro 2000 S

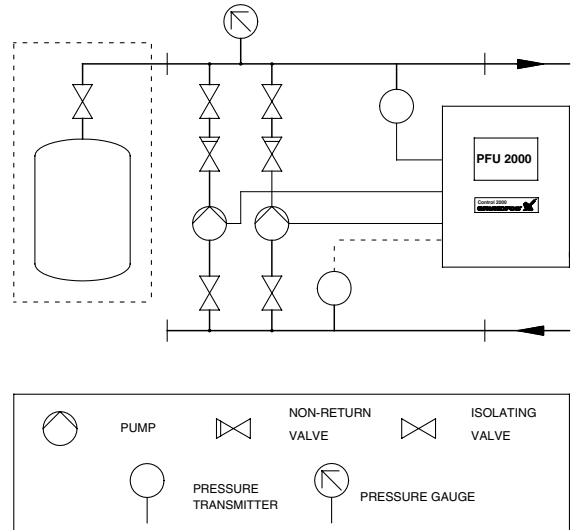

TM00 5391 4796

## 2.2 GRUNDFOS Control 2000 S

The GRUNDFOS Control 2000 S controls a number of pumps on mains operation.

The Control 2000 S always includes the PFU 2000 with application-optimized software, but it is also available with a PMU 2000. The operating conditions and factory settings can be optimized via a temporarily connected PMU 2000.

If the Control 2000 S includes the PFU 2000 only, it will be placed in the front cover. If the Control 2000 S includes both the PFU 2000 and the PMU 2000, the PMU 2000 will be placed in the front cover and the PFU 2000 inside the cabinet.

The Control 2000 S is factory-assembled and tested with the control parameters mentioned in the "List of Control Parameters", which is delivered with the booster set.

### The Control 2000 S offers the following functions:

- Closed-loop control.
- Automatic cascade control of pumps.
- Selection of switching sequences, automatic pump change and pump priority.
- Manual operation.
- Possibility of various analog setpoint influences:
  - friction loss compensation (flow-dependent setpoint control with or without flow measurement),
  - temperature-dependent setpoint control,
  - setpoint adjustment.
- Possibility of various digital remote-control functions:
  - system on/off,
  - reduced operation,
  - setpoint control with two-point switch,
  - setpoint control with three-point switch,
  - alternative setpoint,
  - fire-fighting operation,
  - switching off individual pumps.
- Pump and system monitoring functions:
  - minimum and maximum limits of actual value,
  - pre-pressure,
  - motor protection,
  - BUS communication.
- Display and indication functions:
  - 2 x 24 character LCD display,
  - green indicator light for operating indications and red indicator light for fault indications,
  - potential-free changeover contacts for operation and fault.
- Clock functions.
- GRUNDFOS BUS communication.

Fig. 2

PFU 2000 Front Cover

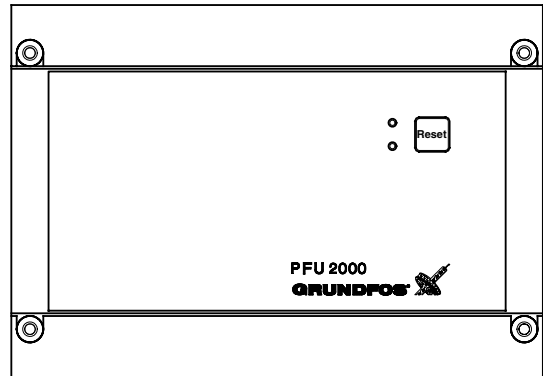

TM00 2721 2397

Fig. 3

PMU 2000 Front Cover

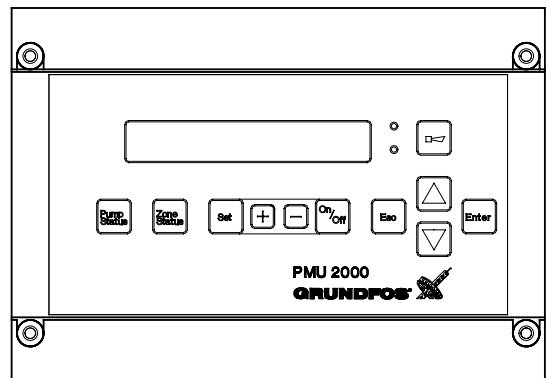

TM00 7023 2497

## 2.2.1 Examples of Booster Sets Hydro 2000 S

Example:

### GRUNDFOS Hydro 2000 MS.

Four pumps and a diaphragm tank.

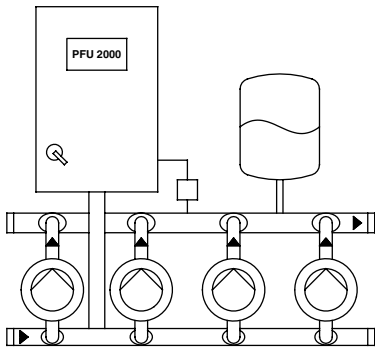

TM00 2674 0294

One pump in operation.

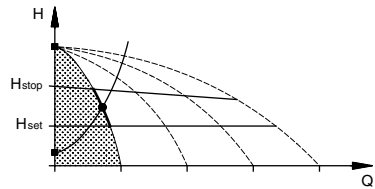

TM00 2749 0294

Three pumps in operation.

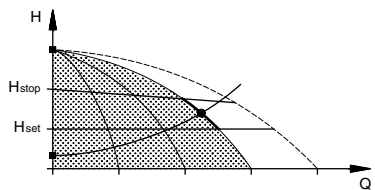

TM00 2751 0294

GRUNDFOS Hydro 2000 MS maintains an almost constant pressure through cutting in/out the required number of pumps.

The operating range of the pumps will lie between the lines  $H_{set}$  and  $H_{stop}$  (cut-out pressure). The cut-out pressure cannot be set but is calculated automatically. Changeover among the pumps is automatic and depends on load, time and fault.

Example:

### GRUNDFOS Hydro 2000 MSH.

One half-size pump, three full-size pumps and a diaphragm tank.

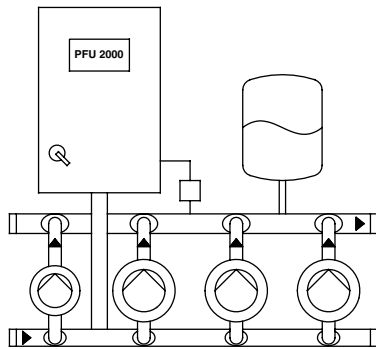

TM00 2678 0294

One half-size pump in operation.

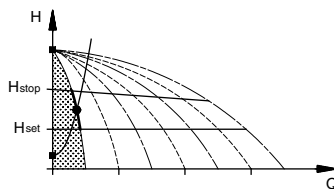

TM00 2773 0294

One half-size pump and one full-size pump in operation.

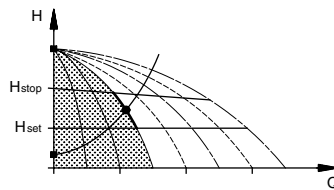

TM00 2775 0294

GRUNDFOS Hydro 2000 MSH maintains an almost constant pressure through cutting in/out the half-size pump and the full-size pumps.

The half-size pump will always start first. The half-size pump will be cut out again when a full-size pump is cut in. The operating range of the pumps will lie between the lines  $H_{set}$  and  $H_{stop}$  (cut-out pressure). The cut-out pressure cannot be set but is calculated automatically. Changeover among the full-size pumps is automatic and depends on load, time and fault.

## 3. Functions

### 3.1 Control Functions and Settings

The display numbers mentioned in the following refer to the display overviews in section 13. *Display Overviews*.

In the PFU 2000, two sets of control parameter settings are stored:

- PFU 2000 EPROM settings, which are default values.
- PFU 2000 RAM settings, which are configuration values. (These values can be changed).

The PFU 2000 RAM settings are configured and displayed in the PMU 2000.

Operation with PFU 2000 EPROM settings or PFU 2000 RAM settings can be changed by means of the DIP switches in the PFU 2000.

The PFU 2000 EPROM default settings and the PFU 2000 RAM settings are listed in the "List of Control Parameters". This list should be updated after each change of setting.

PFU 2000 EPROM settings should not be used for continuous operation. It is preferable to operate the booster set with PFU 2000 RAM settings.

#### 3.1.1 Monitoring Functions

The following functions are available:

- Red indicator light (LED) for indication of fault condition.
- Green indicator light (LED) for indication of operating condition.
- PFU 2000 fault signal relay for indication of fault condition.
- PFU 2000 operating signal relay for indication of operating condition.
- PMU 2000 fault signal relay for indication of fault condition (if a PMU 2000 is installed).
- PMU 2000 operating signal relay for indication of operating condition (if a PMU 2000 is installed).
- GRUNDFOS BUS communication.

See also section 9. *Operating and Fault Indications*.

Fig. 4

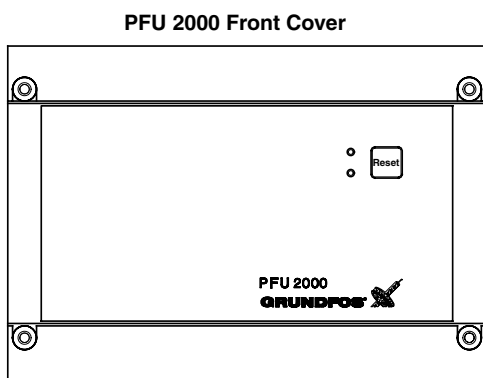
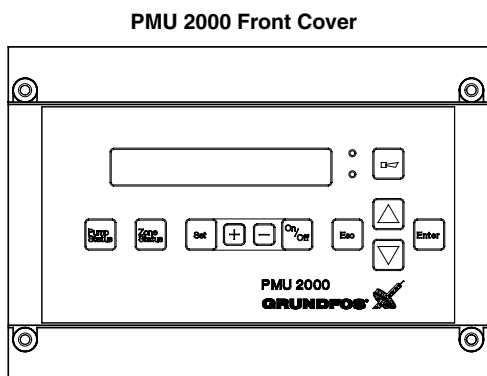

Fig. 5



TM00 2721 2397

TM00 7023 2497

#### 3.1.2 PFU 2000 RAM Settings

The PMU 2000 maintains the PFU 2000 RAM settings as long as the units are connected via the GRUNDFOS BUS.

If a PMU 2000 is to be connected or replaced, please note the following:

**To enter data from a PMU 2000 into the PFU 2000 RAM:**

Fig. 6

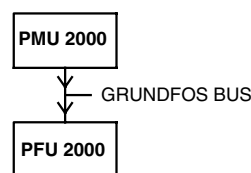

TM00 8462 2896

1. Connect the GRUNDFOS BUS between the PMU 2000 and the PFU 2000.
2. Switch on the electricity supply to the PMU 2000.
3. Switch on the electricity supply to the PFU 2000.
4. The settings from the PMU 2000 will be entered into the PFU 2000 RAM. This operation will take about 1 minute. During this period, the PMU 2000 will display "Master".

**To enter data from a PFU 2000 RAM into the PMU 2000:**

Fig. 7

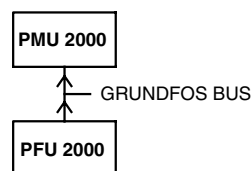

TM00 8461 2896

1. Connect the GRUNDFOS BUS between the PMU 2000 and the PFU 2000.
2. Switch on the electricity supply to the PFU 2000.
3. Switch on the electricity supply to the PMU 2000.
4. The settings from the PFU 2000 RAM will be entered into the PMU 2000. This operation will take about 1 minute. During this period, the PMU 2000 will display "Slave".

For further information, see section 3.1 *Control Functions and Settings*.



### 3.1.3 Closed-Loop Control

The closed-loop controller (a control system with a feed-back signal from a transmitter) is programmed for operation of centrifugal pumps and takes their influence on the hydraulic system into account.

Fig. 8

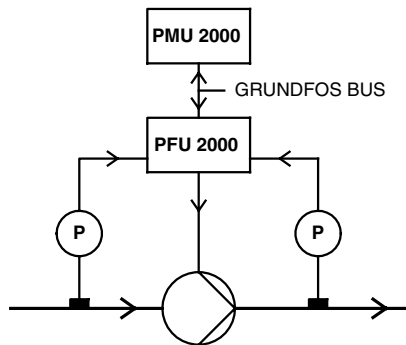

TM00 8277 2596

The only control parameter to be set to adapt the controller to the system conditions is "system time" (display 204), instead of PID parameters as is the case with conventional closed-loop controllers.

- Operation with PFU 2000 RAM / PMU 2000 Settings:  
With the settings in the start/stop menu (displays 300 and 301) and with the function selector in the PFU 2000 within the range from 0% to 100%, the closed-loop controller is operating.
- Operation with PFU 2000 EPROM Settings:  
With the function selector in the PFU 2000 within the range from 0% to 100%, the closed-loop controller is operating.

Fig. 9

#### Function Selector in the PFU 2000

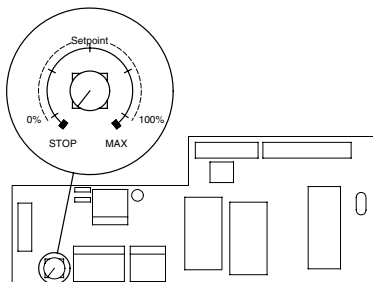

TM00 5217 2796

For further information, see section 3.2.5 Setpoint Influences.

### 3.1.4 Cascade Control

Cascade control ensures automatic matching of the performance to the system demand by cutting in/out the required number of pumps. The controller will operate the system with as few pumps as possible.

The frequency of starts and stops is limited by the setting of minimum and medium switching sequences.

The pumps are cut in if the actual value remains below the setpoint.

With the "control function" (display 214) set to "normal", the switching-off levels for the cascade-controlled pumps are calculated as follows:

#### Operation with PFU 2000 RAM / PMU 2000 Settings:

The actual switching-off level is the lower value of  $H_{stop}$  calculated with PFU 2000 RAM / PMU settings and PFU 2000 EPROM settings.

The  $H_{stop}$  is calculated as:

$$H_{stop} = \frac{\text{On/off-band}}{n} + H_{set}$$

#### Operation with PFU 2000 EPROM Settings:

The  $H_{stop}$  is calculated as:

$$H_{stop} = \frac{H_0 + H_p - H_{set}}{n + 1} + H_{set}$$

$H_{stop}$ : The pressure at which a pump is cut out.

$n$ : Number of pumps in operation.

$H_0$ : Pump head at zero flow.

The default setting of  $H_0$  with PFU 2000 EPROM settings is the highest value of:

setpoint max. + 10% of setpoint or

setpoint max. + 5% of transmitter measuring range.

$H_p$ : Pre-pressure.

$H_{set}$ : Actual setpoint.

On/off-band: The pressure above the setpoint.

If  $H_0 + H_p$  is higher than "max. limit" (display 228), the value for "max. limit" is used instead of  $H_0 + H_p$ .

For further information, see sections 3.2.9 Minimum Switching Sequence, 3.2.10 Medium Switching Sequence and 3.2.17 Minimum Pump Speed Limit.

### 3.1.5 Manual On/Off and Setting to Max. or Local

Operation with PFU 2000 RAM / PMU 2000 Settings:

Fig. 10



In the start/stop menu, the “On/Off” button on the PMU 2000 gives quick access to:

- manual on/off of zone and setting to max. or local,
- manual on/off of individual pumps.

In this menu, the zone and the pumps allocated to this zone appear one by one when the arrow buttons are pressed.

The operating condition of the zone or pump in question is displayed in the top line. In the bottom line, a new status can be selected.

**Start/stop of zones** (display 300):

- “on”  
All pumps in the zone are ready for operation.
- “off”  
All pumps in the zone are switched off.
- “max.”  
All pumps in the zone are operating at maximum performance.
- “local”  
The controller has been set to local mode and will operate according to the local control parameter settings.  
See section 6.2.1 *PFU 2000 DIP Switch Settings*.

If the function selector in the PFU 2000 has been turned to position MAX, the setpoint influences, “clock program” and “remote on/off” are not effective.

**Start/stop of pumps** (display 301):

- “on”  
The pump is ready for operation.
- “off”  
The pump is switched off.

**Operation with PFU 2000 EPROM Settings:**

The controller will operate according to the local control parameter settings.

For further information, see section 6.2.1 *PFU 2000 DIP Switch Settings*.

### 3.1.6 Water Shortage Monitoring

**The water shortage monitoring function switches off all pumps.**

**Note:** If the booster set has been delivered without a water shortage monitor, it should not be started until a water shortage monitor has been installed. Otherwise, there is a risk of damage to the pumps.

If the function “fire fight” (display 222) is activated, the water shortage monitoring function is suppressed.

**Operation with PFU 2000 RAM / PMU 2000 Settings:**

Pre-pressure measuring can be set to “on” or “off” (display 216).

**Via an Analog Signal:**

Set “prepress.measuring” to “on” (display 216) if a pressure transmitter is installed on the suction side of the booster set. The PFU 2000 analog input 2 measures the pre-pressure. The water shortage monitoring will be carried out according to the set “min. prepressure” (display 231).

**Via a Digital Signal:**

Set “prepress.measuring” to “off” (display 216). The signal on the PFU 2000 analog input 2 is evaluated as a digital signal for water shortage monitoring from a pressure switch, level switch or an electrode relay.

**Operation with PFU 2000 EPROM Settings:**

The pre-pressure can be measured via the PFU 2000 analog input 2.

**Via an Analog Signal:**

If the signal is lower than 5% of the measuring range for more than 5 secs., a fault is indicated.

**Via a Digital Signal:**

If the switch contact indicates water shortage for more than 5 secs., a fault is indicated.

For further information, see section

3.2.13 *PFU 2000 Analog Input 2 Configuration*.

### 3.1.7 Automatic Pump Change

There are three possibilities of automatic pump change:

1. Operation-dependent pump change.  
This applies to pumps of equal priority. The pump which is switched on first will be switched off first if the demand falls.
2. Fault-dependent pump change.  
If a pump is faulty, it will be switched off and the next pump ready for operation will be switched on.
3. Time-dependent pump change.  
This ensures that the operating hours are distributed evenly on the pumps in the zone. This function is combined with the test run function.

#### Operation with PFU 2000 RAM / PMU 2000 Settings:

When "pump change" is set to "on" (display 208), time-dependent pump change is carried out at the first time set in "pump change at" "00:00 h" (display 209).

The default setting of "pump change" is "on" (display 208). The default setting of "pump change at" is "00:00 h" (display 209).

If "pump change" is set to "off" (display 208), no time-dependent pump change or test run will be carried out.

#### Operation with PFU 2000 EPROM Settings:

Time-dependent pump change is carried out the first time 5 minutes after the electricity supply has been switched on and then every 24 hours.

### 3.1.8 Test Run

To eliminate the risk of blocking of pumps which are not switched on regularly, a test run is carried out.

The test run causes all operative pumps to be started once between two time-dependent pump changes for 1 sec.

### 3.1.9 Clock Functions

#### Operation with PFU 2000 RAM / PMU 2000 Settings:

If the system demand varies during the day and/or during the week, the pump performance required will also vary. In this case, a clock program can be set in order to achieve optimum performance of the pumps.

It is possible to set a total of 10 switching times, all with individual setpoints.

If "setpoint max." (display 200) is changed after the clock program has been set, the clock program will be changed proportionally.

Application: Time-dependent reduction of setpoint to minimize power consumption or to optimize the performance.

Fig. 11

Clock Program with Three Switching Times

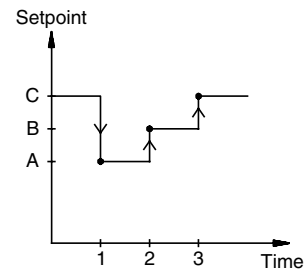

TM00 4989 4894

To ensure correct operation with the clock functions, the time and date can be set in the basic menu of the PMU 2000 (display 103).

Supply failure does not influence the clock program.

#### Operation with PFU 2000 EPROM Settings:

No clock program.

### 3.1.10 Standby Pumps

#### Operation with PFU 2000 RAM / PMU 2000 Settings:

In zones with more than one pump, the number of standby pumps can be selected in "stand-by pumps" (display 226). A standby pump is only started if the duty pump is faulty, not to increase the performance of the system.

The standby pump(s) will be included in the automatic pump change and the test run.

The setting range is from one pump to the number of pumps connected to the zone less one.

The default setting is 0.

If individual pumps are to be defined as standby pumps, these pumps must be set to a lower priority than the duty pumps.

For further information, see section

3.1.12 Pump Priority.

#### Operation with PFU 2000 EPROM Settings:

The default setting is 0.

### 3.1.11 Reduced Operation

#### Operation with PFU 2000 RAM / PMU 2000 Settings:

If reduced operation is activated, a number of pumps, but not individual pumps, can be defined as pumps ready for operation. The system performance is restricted to the set number of pumps.

Reduced operation is activated if the PFU 2000 input 4 is set to "reduced op" (display 222) and the input 4 contact is closed.

The number of pumps required to run when reduced operation is activated is set in the display appearing after display 222.

The setting range is from one pump to the number of pumps connected to the zone less one.

Application: Emergency power operation with a limited performance.

The default setting is 0.

#### Operation with PFU 2000 EPROM Settings:

The default setting is 0.

### 3.1.12 Pump Priority

#### Operation with PFU 2000 RAM / PMU 2000 Settings:

The set "pump priority" (display 227) determines the operating priority of the pumps connected to a zone.

Pumps with the highest priority are switched on first. Pumps with the lowest priority are switched off first.

Pumps of equal priority and equal size are subject to:

First in, first out.

The setting range is 1 (highest priority) to 8 (lowest priority).

In systems type MSH, all pumps must be set to the same priority. Different settings will be ignored.

The default setting is 1.

#### Operation with PFU 2000 EPROM Settings:

The default setting is 1.

### 3.1.13 GRUNDFOS BUS

The GRUNDFOS BUS protocol must be observed in the system configuration, mainly if various controllers are connected via a GRUNDFOS BUS.

Fig. 12

Example of Units Connected via GRUNDFOS BUS

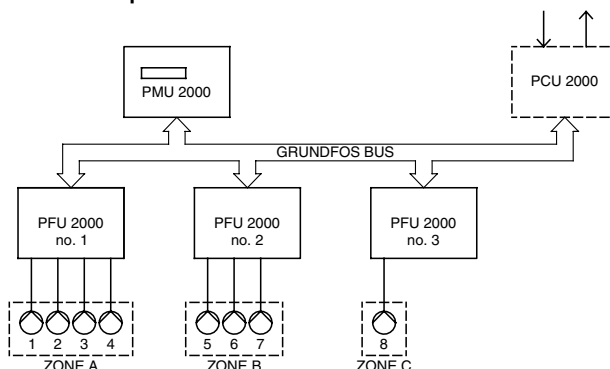

TM00 2744 0294

Possible number of pumps in a zone and on a BUS: 1 to 8.

Pump numbers in a zone or on a BUS: 1, 2, 3, 4, 5, 6, 7, 8.

Number of zones: 1 to 8.

Zone names: A, B, C, D, E, F, G, H.

It is possible to give the zones specific names.

Number of PFU 2000 units in a zone: 1 or 2.

Number of PFU 2000 units on a BUS: 1 to 8.

If more than one PFU 2000 are used in a zone, this must be taken into account when setting the DIP switches in the PFU 2000.

If more than one booster set, e.g. three booster sets, are connected via a GRUNDFOS BUS, the numbering of the pumps, i.e. from 1 to 8, must be made on the GRUNDFOS BUS level.

	Zone A 4 Pumps				Zone B 3 Pumps			Zone C 1 Pump
Zone Pump Number	1	2	3	4	1	2	3	1
BUS Pump Number	1	2	3	4	5	6	7	8

For further information, see section 6.2.1 PFU 2000 DIP Switch Settings and List of Control Parameters.

## 3.2 Control Parameters

The display numbers mentioned in the following refer to the display overviews in section 13. *Display Overviews*.

The influence of the control parameters is described below.

The default settings and the actual settings are listed in the "List of Control Parameters".

### 3.2.1 Allocation of Pumps to Zone

The pumps in the system are organized in zones. The number of pumps in a zone is set by means of the DIP switches in the PFU 2000 and will be applied by the PMU 2000.

If several units are connected via the GRUNDFOS BUS, the GRUNDFOS BUS protocol must be observed.

For further information, see sections

3.1.13 *GRUNDFOS BUS* and

6.2.1 *PFU 2000 DIP Switch Settings*.

### 3.2.2 Zone Type / Control Parameter

#### Operation with PFU 2000 RAM / PMU 2000 Settings:

Zone type and control parameter will activate typical functions.

Only relevant displays will appear in the PMU 2000 display.

The zone type can be preset, but it will also be identified by the PMU 2000 according to the units connected to the GRUNDFOS BUS. The presetting will automatically be changed in case of deviation.

#### Example:

If the zone type has been preset to UPE (display 111) and a PFU 2000 is connected to the zone, the preset zone will automatically be changed into PFU.

In the PMU 2000, the presetting can be made in the submenu "presetting" (display 111) in the basic menu. Presettings are made zonewise. In the presetting submenu, only zones to which pumps have been allocated will appear.

The control parameter can only be selected in the presetting submenu (display 111).

Possible control parameters for zone type PFU:

1. Differential pressure
2. Differential temperature
3. Flow-pipe and return-pipe temperatures
4. Flow
5. Level
6. Open loop
7. Pressure
8. Pressure with pre-pressure measuring

The control parameter is set in two steps:

- Select control parameter number.
- Select measuring unit (if the desired unit differs from the presetting).

For further information, see section

3.2.7 *Measuring Unit for Control Value*.

When changes have been made or presetting has been activated, all pumps will be switched off to enable further settings without the pumps operating under unintended conditions.

For various applications, typical presettings have been made under the presetting control parameter number. When a presetting control parameter is activated, some of the control parameter values are changed accordingly. All other values are set to the default values.

**Note:** The activation of a presetting parameter overwrites actual settings of a zone.

For pressure boosting systems, the control parameter is "pressure" containing all typical functions.

### 3.2.3 Priority of Settings

If "Max." and "Stop" are activated at the same time, the pumps will operate according to the function with the highest priority.

Priority	Possible Settings		
	PFU 2000	PMU 2000	PCU 2000
High	Stop		
	Max.		
		Stop	
		Max.	
Low			Stop
			Max.

#### Example:

If the pumps have been set to stop via the PMU 2000 and at the same time to maximum operation in the PFU 2000, the pumps will run in maximum operation because of the higher priority.

### 3.2.4 Setpoint

#### Operation with PFU 2000 RAM / PMU 2000 Settings:

The maximum setpoint is set in "setpoint max." (display 200). This value is the upper limit of the setpoint and forms the basis of the calculation of "setpoint act." (display 401) which takes all setpoint influences into account. The product of "setpoint max." and all setpoint influences forms "setpoint act.", which is the actual setpoint according to which the closed-loop controller operates.

If the zone has been set to "local" (display 300), "setpoint max." can be set by means of the function selector in the PFU 2000.

"Setpoint max1" (display 222) will be activated if it is set to "on" and the PFU 2000 input 4 contact is closed.

"Setpoint max1" functions like "setpoint max.", but it cannot be influenced by the clock program.

The setting range of "setpoint max." and "setpoint max1" is equal to the measuring range of the actual transmitter.

#### Operation with PFU 2000 EPROM Settings:

The setpoint is set by means of the function selector in the PFU 2000 which has three positions, see fig. 13.

- "STOP"  
All pumps are stopped and no setpoint is set. Fault indications will be reset.
- "0% to 100%"  
By means of the function selector the required pressure can be set within the range from 0% to 100%. 100% corresponds to the maximum value of the transmitter.
- "MAX"  
The PFU 2000 starts all pumps at maximum performance. All internal monitoring functions are active. Remotely set setpoints or external on/off are not active.

Fig. 13

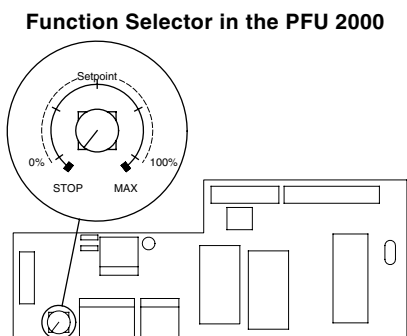

TM00 5217 2796

### 3.2.5 Setpoint Influences

#### Operation with PFU 2000 RAM / PMU 2000 Settings:

In order to optimize the operation of the system, it is often advantageous to operate the system with a variable setpoint instead of a constant setpoint. The selected setpoint influences reduce "setpoint max." according to their settings.

More than one setpoint influence can be active simultaneously. The influence types are described below. The product of all influences and "setpoint max." forms "setpoint act.".

For further information, see section

#### 3.2.4 Setpoint.

**Progressive** = proportional (friction loss compensation):

If the system is to compensate for friction loss, this is possible by selecting progressive influence.

When "progressive infl" is set to "on" (display 202), the pressure will rise with an increasing flow. The actual flow is estimated according to internal operating data without measuring the flow.

"Setpoint act." will be increased linearly from the adjustable percentage at zero flow to 100% "setpoint act." at maximum flow. Maximum flow is the sum of the maximum flows of all the pumps in the zone minus the standby pumps.

Fig. 14

Friction Loss Compensation

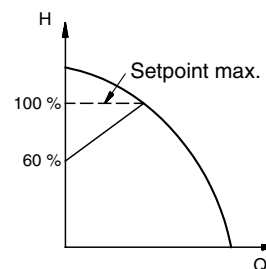

TM00 4991 4894

#### Setpoint Influences via External Signals:

If "influence" is selected (display 217), it is important to set the required table value.

Fig. 15

Example of Setpoint Influence Table

Set A	0 %	-> STOP bar
Set A	50 %	-> 1.5 bar
Set A	80 %	-> 2.5 bar
Set A	100 %	-> 6.0 bar

The following external setpoint influences are possible:

- "off"  
No setpoint influence table (clock program, progressive influence and remote control of setpoint via the PCU 2000 are possible).
- "extern" (%)  
An external analog signal or potential-free contact on the PFU 2000 analog input 3 influences the setpoint in accordance with a table.  
With the PFU 2000 analog input 3 as a 0-10 V input and the setting "extern" %, the input may be used as "remote on/off" for all pumps which have not been defined as 'not to be switched off'.  
If the PFU 2000 input 3 contact is:  
open = maximum value of the table.  
closed = minimum value of the table.  
Examples of application: Changeover to night-time duty or analog setpoint control from a building management system.

- "timer" (minutes)  
An internal timer program in the PMU 2000 controls the setpoint in accordance with a table. This timer is started when the contact on the PFU 2000 input 3 is closed.  
The setting range is 0 to 200 minutes.  
Application: Processes in which a time-controlled shape of the setpoint must be achieved during a certain period.
- "Temp Tf" (°C, °F)  
The flow-pipe temperature (measured on the PFU 2000 input 3) controls the setpoint in accordance with a table.  
Examples of application: Heating and cooling systems.
- "Temp Tr" (°C, °F)  
The return-pipe temperature (measured on the PFU 2000 input 3) controls the setpoint in accordance with a table.  
Examples of application: Heating and cooling systems.
- "Temp To" (°C, °F)  
The ambient temperature (measured on the PFU 2000 input 3) controls the setpoint in accordance with a table.  
Examples of application: Heating and cooling systems.
- "level" (m, cm, ft, in)  
The level signal (PFU 2000 input 3) controls the setpoint in accordance with a table.  
Examples of application: Water supply depending on cistern level. Level control.
- "flow" (m<sup>3</sup>/h, l/h, l/s, gpm)  
The flow signal (PFU 2000 input 3) controls the setpoint in accordance with a table.  
Examples of application: Flow-dependent compensation of pressure drop in water supply systems or differential pressure drop compensation in circulation systems if a flow meter signal is available.

**Remote Control of Setpoint via a PCU 2000:**

Via PCU 2000 inputs for the pumps connected to the zone and the GRUNDFOS BUS, the setpoint may be controlled linearly to the PCU 2000 input signal.

**Operation with PFU 2000 EPROM Settings:**

**Setpoint Influences via External Signals:**

The PFU 2000 input 3 can be connected to a 0-10 V signal for remote setting of setpoint.

**Fig. 16**

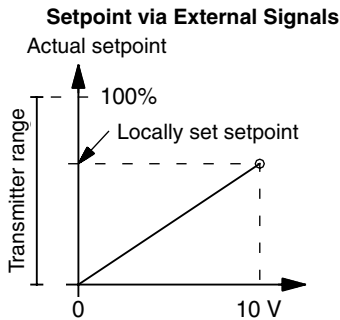

TM00 7048 0296

The locally set setpoint is set by means of the function selector in the PFU 2000, see fig. 13.

**3.2.6 On/Off Band**

The on/off band (display 207) is the pressure above the actual setpoint that is used to calculate the switch off levels for the pumps.

**Operation with PFU 2000 RAM / PMU 2000 Settings:**

The default setting for the on/off band is 10% of the measuring range of the signal transmitter.

**Operation with PFU 2000 EPROM Settings:**

The default setting for the on/off band is 10% of the measuring range of the signal transmitter.

For further information, see section

*3.1.4 Cascade Control.*

### 3.2.7 Measuring Unit for Control Value

#### Operation with PFU 2000 RAM / PMU 2000 Settings:

If the signal transmitter used features a measuring unit different from the one in the presetting, an alternative measuring unit can be selected (display 213). The measuring unit selected will automatically be changed in the relevant displays, but the measuring range of the signal transmitter will not be converted automatically. It is also important to convert and set the output signal as well as minimum and maximum values of the signal transmitter operating range (displays 219 and 220).

The following measuring units can be selected:

1. Differential pressure: m, Pa, ft, kPa.
2. Differential temperature: K, °F.
3. Temperature: °C, °F.
4. Flow: m<sup>3</sup>/h, l/h, l/s, gpm.
5. Level: m, cm, ft, in.
6. Open loop: %.
7. Pressure: bar, mbar, psi, kPa.
8. Pressure with pre-pressure measuring: bar, mbar, psi, kPa.

#### Operation with PFU 2000 EPROM Settings:

See section 6.2.1 PFU 2000 DIP Switch Settings.

### 3.2.8 System Time

System time is an adjustable parameter to adapt the behaviour of the controller to the hydraulic system (display 204). System time is defined as the time that passes from a change in pump speed is made until the measured value reaches approx. 70% of the corresponding final change.

#### Operation with PFU 2000 RAM / PMU 2000 Settings:

With the control parameter "pressure", the recommended setting is 2 secs.

A lower setting involves the risk of hunting.

A higher setting causes delays in reaching the setpoint.

The setting range is 0.4 to 800 secs.

#### Operation with PFU 2000 EPROM Settings:

The default setting is 2 secs.

Fig. 17

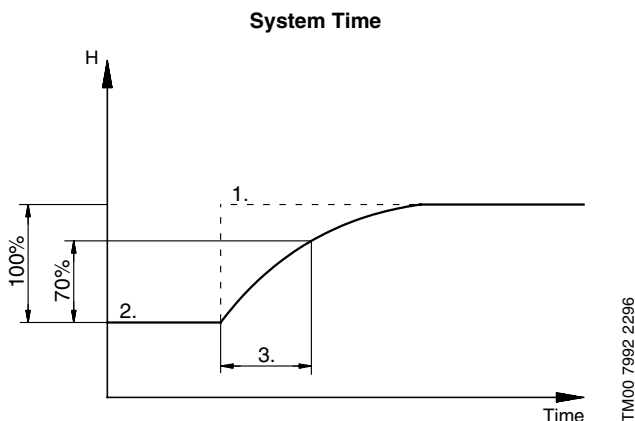

TM00 7992 2296

1. Final value after a jump in speed.
2. Actual value.
3. System time.

### 3.2.9 Minimum Switching Sequence

Minimum switching sequence is the time between two switchings (on/off of pumps).

#### Operation with PFU 2000 RAM / PMU 2000 Settings:

To prevent hunting in the system and to limit pressure and current surges, a minimum time between switching the individual pumps on and off can be set (display 205).

The higher the set value (sec.), the bigger the risk of differences between setpoint and actual value.

In order to avoid that the "actual value" exceeds "max. limit", the minimum switching time is temporarily set to 1 sec. if the actual value exceeds the mean value between "setpoint max." and "max. limit".

The setting range is 2 to 300 secs.

For further information, see section 3.1.4 Cascade Control.

#### Operation with PFU 2000 EPROM Settings:

The default setting is 5 secs.

### 3.2.10 Medium Switching Sequence

Medium switching sequence is the time that describes the maximum number of switchings (on/off of pumps) per hour under normal conditions.

#### Operation with PFU 2000 RAM / PMU 2000 Settings:

This setting is only possible on service code level.

In case of frequent starts and stops, this function prolongs the operating time of the pump in order not to exceed the permissible number of switchings.

The medium switching time (sec.) to be set is calculated as 3600 s/permissible maximum number of switchings per hour.

Unnecessarily high settings may result in differences between setpoint and actual value. This can be avoided by accepting more frequent pump changes.

In order to avoid that the "actual value" exceeds "max. limit", the medium switching time is temporarily set to 1 sec. if the actual value exceeds the mean value between "setpoint max." and "max. limit".

If the medium switching time is effective with a mains-operated pump in operation, the actual value may exceed the setpoint set.

The setting range is 2 to 300 secs.

For further information, see section 3.1.4 Cascade Control.

#### Operation with PFU 2000 EPROM Settings:

The default setting is 5 secs.



### 3.2.11 Control Function

#### Operation with PFU 2000 RAM / PMU 2000 Settings:

The “control function” (display 214) determines how the system is to react to any difference between the actual value and the setpoint set.

The following control functions are possible:

- “normal”  
If the actual value is lower than the setpoint, the pump performance will be increased (the controller amplifies the output signal).
- “invers”  
If the actual value is lower than the setpoint, the pump performance will be reduced (the controller diminishes the output signal).

Dependent on the control parameter selected, the required control function is as follows:

“Normal” is required for the control parameters “pressure”, “differential pressure”, “flow” and “level” (filling).

“Invers” is required for the control parameters “differential temperature” and “level” (draining).

### 3.2.12 PFU 2000 Analog Input 1 Configuration

The PFU 2000 analog input 1 value is the measured value in the system. The PFU 2000 receives a signal from the signal transmitter installed. The evaluation of the input signal depends on the setting of the control parameter, the transmitter measuring range and the measuring unit of the actual value.

In the wiring diagram and the PFU 2000 EPROM default settings, a 4-20 mA pressure measuring signal has been applied.

The necessary hardware configuration is described in section *6.2.1 PFU 2000 DIP Switch Settings*.

### 3.2.13 PFU 2000 Analog Input 2 Configuration

The PFU 2000 analog/digital input 2 is only used for pre-pressure measuring (only for control parameter “pressure with pre-pressure measuring”).

A digital signal (potential-free contact NC or NO) or the following analog signals can be connected and evaluated: 0-10 V, 0-20 mA or 4-20 mA.

The necessary hardware configuration is described in section *6.2.1 PFU 2000 DIP Switch Settings*.

### 3.2.14 PFU 2000 Analog Input 3 Configuration

The PFU 2000 analog input 3 receives a setpoint influence signal in accordance with the setting in “setp. influence” (display 202).

The necessary hardware configuration is described in section *6.2.1 PFU 2000 DIP Switch Settings*.

The default function of the PFU 2000 analog input 3 without a PMU 2000 is “extern” in % (linearly from 0% to 100%).

For further information, see section *3.2.5 Setpoint Influences*.

### 3.2.15 PFU 2000 Input 4 Configuration

The PFU 2000 digital input 4 can be used for external control of the zone. Only one function per zone can be selected.

#### Operation with PFU 2000 RAM / PMU 2000 Settings:

The default setting is "off".

The following functions are possible (display 222):

- "off"  
Input 4 has no function.
- "remote on/off"  
When the PFU 2000 input 4 contact is opened, all pumps are switched off.
- "ramp 2 pt" (two-point control of setpoint)  
When the PFU 2000 input 4 contact is closed, the setpoint will drop linearly in accordance with the set "ramp time" (display 223).  
When the contact is opened, the setpoint will rise linearly in accordance with the set "ramp time" (display 223).  
The default setting is "setpoint act."

Fig. 18

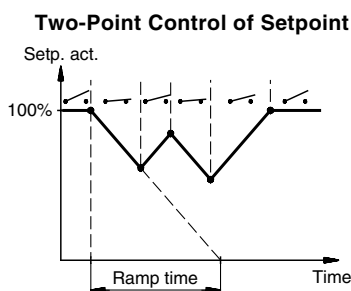

TM00 5004 4894

- "ramp 3 pt" (three-point control of setpoint)  
The PFU 2000 input 2 is used for this function together with input 4. The function "ramp 3 pt" is not possible with control parameters using the PFU 2000 input 2.  
When the PFU 2000 input 4 contact is closed, the setpoint will drop linearly in accordance with the set "ramp time" (display 223).  
When the PFU 2000 input 2 contact is closed, the setpoint will rise linearly in accordance with the set "ramp time" (display 223).  
When the PFU 2000 input 2 and PFU 2000 input 4 contacts are opened, the setpoint will be kept constant.  
When both contacts are closed, the setpoint will drop linearly by a factor of 1 to 0 in accordance with the set "ramp time".  
The default setting is "setpoint act."

Fig. 19

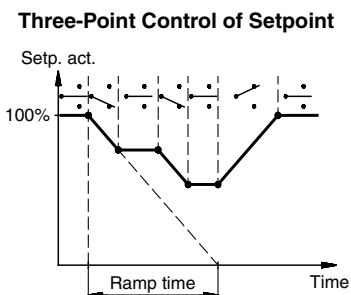

TM00 5005 4894

- "reduced op" (reduced operation)  
When the PFU 2000 input 4 contact is closed, the pumps which have not been set to reduced operation will be switched off, i.e. the system performance is reduced to the number of pumps set to reduced operation.  
Examples of application: Reduced power supply with an emergency power set. Reduced permissible water consumption in case of limited source capacity.

For further information, see section 3.1.11 *Reduced Operation*.

- "setpoint max1"  
When the PFU 2000 input 4 contact is closed, "setpoint max1" will be activated.
- "fire fight"  
This function is only available with control parameters "pressure" and "pressure with pre-pressure measuring".  
When the PFU 2000 input 4 contact is opened, "setpoint max1" will be activated. At least one pump is started. The water shortage monitoring function is suppressed.
- "flowswitch"  
This function is only available with control parameters "pressure" and "pressure with pre-pressure measuring".  
The pumps will be stopped when the PFU 2000 input 4 contact is opened and the actual pressure is higher than the setpoint set.

#### Operation with PFU 2000 EPROM Settings:

The default setting is "remote on/off".

### 3.2.16 Ramp Time

#### Operation with PFU 2000 RAM / PMU 2000 Settings:

The ramp time is the time needed to change the setpoint factor from 0 to 1 and vice versa.

If the PFU 2000 input 4 has been set to "ramp 2 pt" or "ramp 3 pt" (display 222), the ramp time must be set (display 223).

The setting range is 1 to 99 minutes.

The default setting is 10 minutes.

Fig. 20

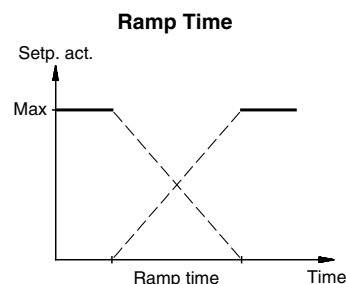

TM00 5006 4894

### 3.2.17 Minimum Pump Speed Limit

#### Operation with PFU 2000 RAM / PMU 2000 Settings:

Minimum pump speed limits the lowest operating point. The value is set in the setting menu.

The setting range is 0% to 100%.

100% is equal to the performance of one full-size pump.

50% is equal to the performance of one half-size pump.

If the minimum speed setting is higher than 0, the on/off mode is avoided.

The default setting is 0.

#### Operation with PFU 2000 EPROM Settings:

The default setting is 0.

Fig. 21

Minimum Pump Speed Limit

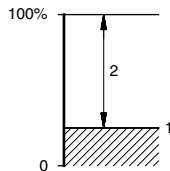

1. Minimum pump speed limit.
2. Operating range.

TM00 8298 2596

### 3.2.18 Maximum Limit (Overpressure)

#### Operation with PFU 2000 RAM / PMU 2000 Settings:

This setting defines the maximum limit at which the system is to indicate a fault.

In pressure boosting systems with control parameter "pressure", it is overpressure.

The setting range is from 0 to the maximum value of the transmitter measuring range (display 228). If the value is set to the maximum of the measuring range, no fault will be indicated.

The default setting in the PMU 2000 is the maximum value of the measuring range – 1 digit.

#### Operation with PFU 2000 EPROM Settings:

The default setting is the maximum value of the transmitter measuring range – 1 digit.

For further information, see section 7.3.3 *Maximum Limit of Actual Value*.

Fig. 22

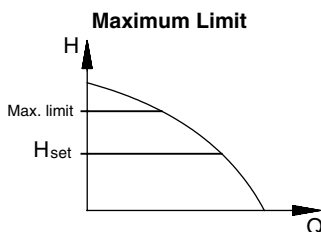

TM00 8296 2596

### 3.2.19 Minimum Limit

#### Operation with PFU 2000 RAM / PMU 2000 Settings:

This setting defines the minimum limit at which the system is to indicate a fault.

Examples of application: Elimination of operation in unintended operating points. Detection of pipe bursts.

The setting range is from 0 to the maximum value of the transmitter measuring range (display 229). If the value is set to 0, no fault will be indicated.

The default setting is 0.

#### Operation with PFU 2000 EPROM Settings:

The default setting is 0.

For further information, see section, 7.3.4 *Minimum Limit of Actual Value*.

Fig. 23

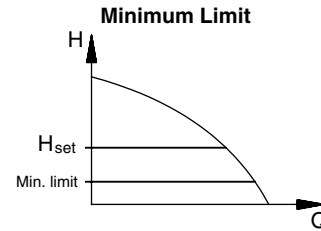

TM00 8297 2596

### 3.2.20 Operation at Minimum Limit

#### Operation with PFU 2000 RAM / PMU 2000 Settings:

If this function is set to "on" (display 230), no pumps will be switched off at "min.limit operation", but a fault is indicated.

If this function is set to "off" (display 230), the pump/pumps is/are switched off at "min.limit operation" and a fault is indicated.

The default setting is "on".

### 3.2.21 Minimum Pre-Pressure

#### Operation with PFU 2000 RAM / PMU 2000 Settings:

If pre-pressure measuring is set to "on" (display 216), the setting of minimum pre-pressure (display 231) defines the value for the water shortage fault indication.

The default setting is 0.

#### Operation with PFU 2000 EPROM Settings:

The default setting is 5% of the transmitter measuring range.

## 3.3 Pump Parameters

#### Operation with PFU 2000 RAM / PMU 2000 Settings:

These settings are only possible on service code level.

The control functions take "maximum head" and "start time" for each pump into account.

The operating hours are counted.

The settings are listed in the "List of Control Parameters".

### 3.3.1 Maximum Head

#### Operation with PFU 2000 RAM / PMU 2000 Settings:

This setting is only possible on service code level.

The maximum head  $H_0$  is the head at maximum speed and flow = 0. It influences the calculation of the speed settings during switching and pump change processes (display 232).

Pump head = discharge pressure – pre-pressure.

If the pre-pressure is not measured, it is set to zero in the formula.

The value must be set according to the  $H_0$  stated on the pump nameplate.

The setting range is 0 to the maximum value of the measuring range of the relevant analog input.

The default setting is the maximum value of the measuring range of the relevant analog input.

#### Operation with PFU 2000 EPROM Settings:

The default setting is the higher value of:

- setpoint max. + 10% of setpoint or
- setpoint max. + 5% of transmitter measuring range.

### 3.3.2 Operating Hours

#### Operation with PFU 2000 RAM / PMU 2000 Settings:

The operating hours are counted for each pump when operating.

When a pump is replaced, the operating hours for the pump can be changed (display 233).

### 3.3.3 Start Time

#### Operation with PFU 2000 RAM / PMU 2000 Settings:

This setting is only possible on service code level.

The “start time” is the time a pump needs to run up to maximum speed after having been started. The value is set in the setting menu.

This parameter is used to calculate the timing of speed settings when a pump is stopped and during pump change.

The setting range is 0 to 100 secs. in steps of 0.1 sec.

The default setting is 1.0 sec.

#### Operation with PFU 2000 EPROM Settings:

The default setting is 1.0 sec.

Fig. 24

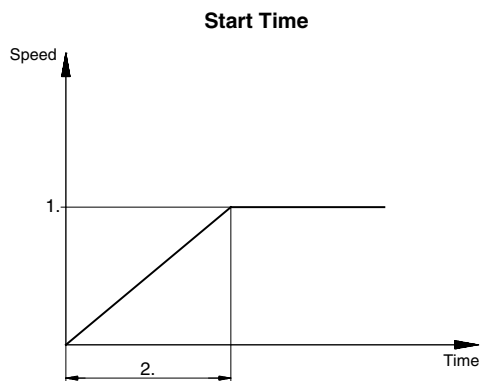

1. Maximum speed.
2. Start time.

## 4. Installation



The installation and operation should be in accordance with local regulations and accepted codes of good practice.

## 4.1 Location

The booster sets Hydro 2000 S must be installed in a well ventilated room. Hydro 2000 S is not suitable for outdoor installation.

The booster set should be placed with a 1 metre clearance in front and on the two sides.

Use a fork-lift truck to move the booster set. It is shown on the booster set where it can be lifted.

## 4.2 Hydraulic Installation

Arrows on the pump base show the direction of flow of water through the pump.

The pipes connected to the booster set must be of adequate size. To avoid resonance, expansion joints should be fitted in the discharge and suction pipes, see fig. 25.

The pipes are connected to the manifolds of the booster set. Either end can be used. Apply sealing compound to the unused end of the manifold and fit the screw cap. For manifolds with flanges, a blind flange with gasket must be fitted.

The booster set should be tightened up prior to start-up.

If booster sets are installed in blocks of flats or the first consumer on the line is close to the booster set, it is advisable to fit pipe hangers on the suction and discharge pipes to prevent vibration being transmitted through the pipework, see fig. 25.

The booster set should be positioned on a plane and solid surface, e.g. a concrete floor or foundation. If the booster set is not fitted with vibration dampers, it must be bolted to the floor or foundation.

The pipes must be fastened to parts of the building to ensure that they cannot move or be twisted.

Fig. 25

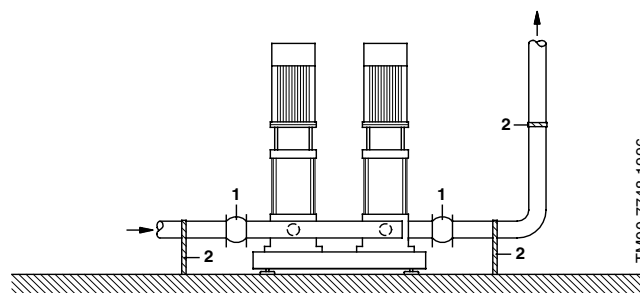

1. Expansion joint.
2. Pipe hanger.

Expansion joints, pipe hangers and vibration dampers shown in fig. 25 are not included in the standard booster set.

## 4.3 Electrical Connection

The connection of electricity supply, transmitters and external monitoring equipment must be carried out by an authorized electrician in accordance with local regulations and the relevant wiring diagram.

Make sure that the Control 2000 S and the pumps are suitable for the electricity supply on which they will be used. Pay special attention to “Important Notes” in the wiring diagram.

If the motors cannot be seen from the control box, they must be fitted with a repair switch.

For further information, see section 11.4 *Electrical Data*.

## 5. Start-Up

### 5.1 Hydro 2000 S without a PMU 2000

To start up a booster set Hydro 2000 S without a PMU 2000, follow this procedure:

1. Check that the booster set corresponds to the one that was ordered and that no single parts have been damaged.
2. Connect water and electricity supplies.  
Check that the wire cross-section corresponds to the specifications in the wiring diagram.  
Switch off the automatic circuit breakers of all pumps.
3. Close the discharge valves of the pumps and prime the booster set and the suction pipe.  
Check that the pressure in the diaphragm tank is 0.7 times the required discharge pressure (setpoint).  
Repeat this procedure for all pumps.
4. Turn the function selector in the PFU 2000 to "MAX".  
Switch on the automatic circuit breaker of pump 1.  
Switch on the automatic circuit breaker for the control current.  
After approx. 15 secs., motor 1 will start.  
Vent the pump while slowly opening its discharge valve.  
Repeat this procedure for all pumps.

Fig. 26

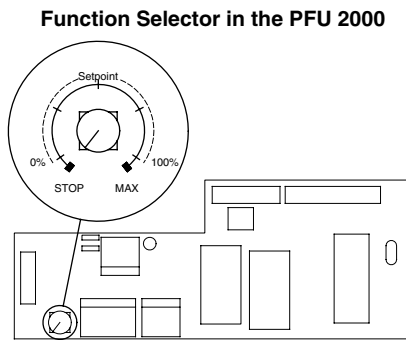

TM00 5217 2796

5. Hydro 2000 S has now been vented and is ready for running-in. Check that the DIP switches in the PFU 2000 have been set correctly.
6. Turn the function selector to 50%. The booster set will now start. Establish a consumption of approx. 50% of the performance of one pump and await stable operation.
7. Adjust the function selector slowly until the required discharge pressure can be read on the pressure gauge.  
**Note:** When changing the discharge pressure, change the diaphragm tank precharge pressure accordingly.
8. Check that the pumps cut in and out and adjust the performance to the consumption.

Hydro 2000 S is now ready for operation.

#### 5.1.1 Setting via a Temporarily Connected PMU 2000

The factory-set standard values in the PFU 2000 RAM can be changed via a temporarily connected PMU 2000.

For further information, see section 3.1.2 PFU 2000 RAM Settings.

### 5.2 Hydro 2000 S with a PMU 2000

To start up a booster set Hydro 2000 S with a PMU 2000, follow this procedure:

1. Pull out the connection plug (BUS) in the PMU 2000, see fig. 27, and proceed according to points 1 to 8 in section 5.1 Hydro 2000 S without a PMU 2000.

Fig. 27

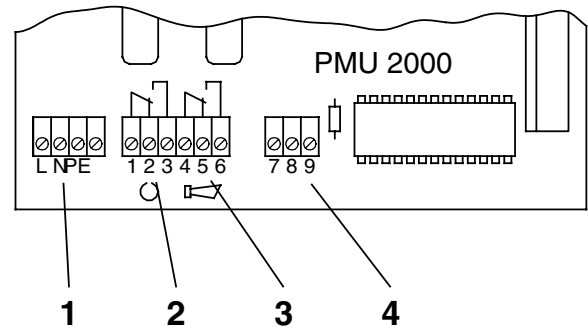

TM00 7802 2096

1. Electricity supply
2. Operating signal output
3. Fault signal output
4. BUS (connection plug)

2. Plug the connection plug (BUS) into the PMU 2000.
3. Allocate all pumps to the same zone (display 101).
4. Move from "presetting" (display 102) to display 111. For quick setting-up of a Hydro 2000 S with a PMU 2000, select presetting:
  - Select "pressure" for booster sets without pre-pressure measuring (PFU 7).
  - Select "pressure with pre-pressure measuring" for booster sets with pre-pressure measuring (PFU 8).
Further adjustment can be carried out later on.  
The presettings are based on a 4-20 mA transmitter (0-10 bar). If transmitters with other signal ranges are used, please adjust accordingly.
5. In the presetting, "setpoint max." is set to 5 bar which can be changed to the required level in display 200.
6. Release the pumps for operation in display 300.
7. If Hydro 2000 S is to be operated without a PMU 2000, it can operate either on the basis of the EPROM settings in the PFU 2000 (DIP switch 1, contact 5 ON) or on the basis of the data stored in the PFU 2000 RAM (DIP switch 1, contact 5 OFF).

### 5.3 Direction of Rotation

The Control 2000 S has been wired for equal direction of rotation for all motors.

The motors must rotate in the correct direction. Check the direction of rotation by manually switching the pumps on and off one by one.

- In case of wrong direction of rotation of all motors, interchange two phases at the mains supply terminals.
- In case of wrong direction of rotation of one motor, interchange two phases at the motor in question.

Hydro 2000 S is now ready for operation.

For further information, see section

3.1.5 Manual On/Off and Setting to Max. or Local.

## 5.4 Taking out of Operation

To take the booster set Hydro 2000 S out of operation, switch off the mains switch.



The leads in front of the mains switch are still energized. Lock the mains switch to ensure that it cannot be accidentally switched on.

Individual pumps are taken out of operation by switching off the corresponding motor starter, automatic circuit breaker or fuse.

## 6. Operation

### 6.1 Operation of PMU 2000

Fig. 28

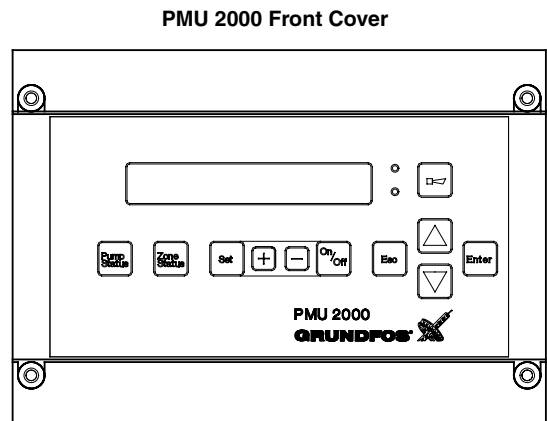

TM00 7023 2497

It is possible to go through all menus and all settings, also during operation, without disturbing the system. Use this possibility to make yourself familiar with the PMU 2000 menus. However, the "Enter" button must not be pressed if unintentional settings have been made.

All settings are buffered, also if the electricity supply is switched off.

Explanation to the front cover operating buttons:

	Status displays for all pumps connected.
	Status displays for all zones.
	Setting menus for all control parameters.
	Setting of control parameter for zones/pumps.
	Setting of control parameter for zones/pumps.
	Start/stop of zones and pumps.
	Jumps one level backwards.
	Survey of fault indications.
	Moves one display up in menu.
	Moves one display down in menu.
	<ul style="list-style-type: none"> <li>- Jumps one level forwards.</li> <li>- Stores settings.</li> <li>- Resets fault indications.</li> </ul>

### 6.1.1 Display Rules

The displays appearing in the PMU 2000 menu are dependent on the settings and the data transmitted from the units connected to the GRUNDFOS BUS.

The displays which are not relevant according to the settings and the units connected to the GRUNDFOS BUS will be suppressed.

All possible displays and values defined in the software will appear if they have not been suppressed as described above.

### 6.1.2 Status Display

The status display is the first display that appears when the PMU 2000 is switched on.

Fig. 29

100	Status	1	2	3	4	5	6	7	8
		I	I	A	I	O	I	-	-

If the PMU 2000 is not operated for 15 minutes, it will automatically return to this display.

By pressing "Esc" repeatedly, you can always return to this display.

The status display indicates the following:

- [I] Pumps 1, 2, 4 and 6 are operating.
- [A] Fault indication on pump 3.  
The fault can be identified in the fault indication menu.
- [O] Pump 5 is not operating.  
The reason can be found in the pump status menu.
- [-] Pump 7 is allocated to a zone, but it has not yet been connected to the PMU 2000 or the electricity supply to the pump was never switched on.
- [ ] Pump 8 has not been allocated to any zone.

A point between two pump numbers indicates that these pumps have been connected to a PCU 2000. The display shows that pumps 1, 2, 3 and 4 have been connected to a PCU 2000.

To find the units in the Control 2000 S, see the wiring diagram and the mechanical layout.

### 6.2 Configuration of the PFU 2000

The DIP switch settings are shown in the "List of Control Parameters".

As an example, figure 30 shows the positions of DIPs 1 and 2 and the following settings:

- Pump number of the first pump in the zone: 1.
- Water shortage monitoring with a contact signal.
- Operation on the basis of EPROM settings.
- No friction loss compensation.
- Discharge pressure transmitter: 4-20 mA signal.
- External setpoint: 0-10 V signal.
- Number of PFU 2000 units in the zone: 1.
- Number of pumps controlled: 2.

See also table in section 6.2.1 PFU 2000 DIP Switch Settings.

Fig. 30

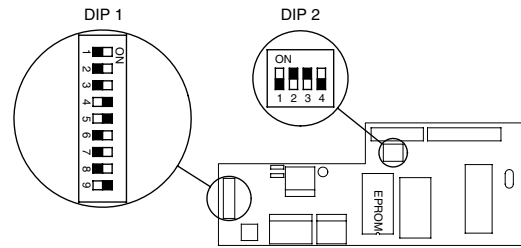

TM00 5216 0296





★ If DIP 1 switch 5 has been set to “ON”, the following parameters can be set by means of DIP 1 switches 1, 2, 3 and 6:

Setting of on/off band	DIP 1			
	1	2	3	6
<b>Very small</b>				
0.5 bar (0-10 bar pressure sensor) 0.7 bar (0-16 bar pressure sensor)	ON	ON		
<b>Small</b>				
0.7 bar (0-10 bar pressure sensor) 1.1 bar (0-16 bar pressure sensor)	ON	OFF		
<b>Normal</b>				
1.0 bar (0-10 bar pressure sensor) 1.6 bar (0-16 bar pressure sensor)	OFF	OFF		
<b>Large</b>				
1.5 bar (0-10 bar pressure sensor) 2.4 bar (0-16 bar pressure sensor)	OFF	ON		
Setting of system time, minimum switching sequence and medium switching sequence	DIP 1			
	1	2	3	6
<b>Quick</b>				
System time 0.8 secs. Minimum switching sequence 2 secs. Medium switching sequence 10 secs.			OFF	ON
<b>Normal</b>				
System time 2 secs. Minimum switching sequence 5 secs. Medium switching sequence 20 secs.			OFF	OFF
<b>Slow</b>				
System time 10 secs. Minimum switching sequence 10 secs. Medium switching sequence 120 secs.			ON	ON
<b>Very slow</b>				
System time 60 secs. Minimum switching sequence 20 secs. Medium switching sequence 300 secs.			ON	OFF

### 6.2.2 Configuration of PCU Relays

To match the function of the PCU 2000, the PCU relays can be configured via the PMU 2000 to the desired functions. The PCU relay configuration is listed in the “List of Control Parameters”.

## 7. Monitoring Functions

### 7.1 Faults, General

Fault conditions in the system are indicated by:

- Red indicator light (LED).
- PFU 2000 fault signal relay.
- PMU 2000 fault signal relay.
- PMU 2000 LCD display.
- PCU 2000 fault signal relays, if installed and configured.

In the PFU 2000 RAM or PMU 2000, if connected, the last 10 fault indications are stored in an agenda by time, occurrence and correction. If more than 10 faults occur, the actual faults and the latest non-actual faults will be kept in the fault agenda. Non-actual faults remain stored until they are reset on the PMU 2000. This does not apply to the faults exceeding 10.

For further information, see section

9. *Operating and Fault Indications.*

**Manual resetting** (restarting of PFU 2000):

A manual reset followed by an immediate restart is carried out in one of the following ways:

- Press the “Reset” button on the PFU 2000.
- Turn the function selector in the PFU 2000 to STOP.
- Reset the fault indication(s) having caused the stop by pressing “Enter” in the fault indication menu of the PMU 2000.
- Reset the fault indication via a PCU 2000 by connecting all reset inputs in parallel.

In the PFU 2000, manual resetting is only possible every 5th second.

**Automatic resetting** (restarting of PFU 2000):

When the actual fault has been corrected, the system will attempt to restart automatically at the following intervals:

- 1st time after 15 secs.,
- 2nd time after 5 minutes,
- 3rd - 4th time at 30 minute intervals,
- 5th - ? time once every 24 hours until the fault has been corrected.

Hydro 2000 S will not restart automatically until the fault has been corrected.

Each fault condition, except for faults which do not disturb the operation, increases the number of restarting attempts.

The number of stored restarting attempts is reduced to zero by manual resetting and a restarting attempt can be made immediately.

Otherwise, the number of stored restarting attempts will be reduced by one every three hours after the alarm disappears. After a certain time without faults, the first automatic restarting attempt can be made 15 secs. after the fault has been corrected.

The fault conditions are described in the following sections.

## 7.2 Pump- and Motor-Related Faults

### 7.2.1 Communication Faults

#### “communicat”

If a fault occurs in the communication via the GRUNDFOS BUS to the units connected, the fault indication “communicat” will be generated and sent to the BUS. It appears after the respective unit in the fault indication menu of the PMU 2000.

Possible causes of communication faults:

- The electricity supply to the unit is switched off.
- The BUS connection to the unit has been disconnected.
- The communication message from the unit cannot be interpreted.
- The same pump number has been allocated to two or more pumps of the same type.

The communication fault will be suppressed (not registered) if the electricity supply is interrupted for less than 20 secs. The fault indication will appear (be registered) if the electricity supply is interrupted for more than 1 minute.

### 7.2.2 Motor Overtemperature

#### “motor temp”

Mains-operated motors with a  $I_e$  up to 25 A are protected by means of a motor starter.

Mains-operated motors with a  $I_e$  between 25 A and 63 A are protected by means of overload relay and circuit breaker.

Additional protection by means of thermistor or winding protection integrated in the motor.

Motor overload will release the respective overload relay. Short-circuit will release the automatic circuit breaker that switches off the electricity supply to the motor.

The thermistor or winding protection switch generates a fault if the motor temperature is exceeded. The fault indication will appear 4 secs. after tripping. The pump will be switched off.

## 7.3 Zone-Related Faults

### 7.3.1 Transmitter Fault

#### “fault zone X sensor AIX”

If a transmitter fault is registered, the fault indication “fault zone X sensor AI X” appears.

Transmitters with current output 0-20 mA or 4-20 mA and temperature transmitters NTC 150 (0-150 °C) or NTC 50 (-25-50°C) are monitored according to the following signal limits:

Sensor AI 1 to sensor AI 3 fault

- 4-20 mA  
AI X < 2 mA or AI X > 22.5 mA for 5 secs.
- 0-20 mA  
AI X > 22.5 mA for 5 secs.
- NTC 150 and NTC 50  
AI X < 0.3 V for 5 secs.

Transmitter faults disappear if the transmitter signal lies within the fault limits for 5 secs.

Transmitters with 0-10 V output signal cannot be monitored because the total measuring range of the electronics is 0-10 V only.

### 7.3.2 Water Shortage

#### “watershort”

The fault indication is “watershort”.

### 7.3.3 Maximum Limit of Actual Value

#### “max. limit”

If the actual value is higher than the set value of maximum limit (display 228) for more than 0.5 secs., the fault indication “max. limit” appears.

With the control parameter “pressure”, this is the overpressure fault.

When the actual value has been lower than the set maximum limit for 5 secs., the actual fault condition will disappear.

For further information, see section *3.2.18 Maximum Limit (Overpressure)*.

### 7.3.4 Minimum Limit of Actual Value

#### “min. limit”

If the actual value is lower than the set value of minimum limit (display 229) for more than 5 secs. + start time + (2 x system time), the fault indication “min. limit” appears.

When the actual value has been higher than the set minimum limit for 5 secs., the actual fault condition will disappear.

For further information, see section *3.2.19 Minimum Limit*.

### 7.3.5 Any Fault in the Zone

If a PCU 2000 is connected to the BUS and configured, it is possible to use the relay function to indicate all faults in a zone.

For further information, see section *6.2.2 Configuration of PCU Relays*.

### 7.3.6 Fault in Any Motor

If a PCU 2000 is connected to the BUS and configured, it is possible to use the relay function to indicate faults in any motor.

For further information, see section *6.2.2 Configuration of PCU Relays*.

## 7.4 System-Related Faults

### 7.4.1 Voltage Drop

#### “mains drop”

The PMU 2000 is monitored for voltage drops. Voltage drops which persist for more than one minute will be indicated as faults.

After restarting of the PMU 2000, the time when the voltage drop occurred and the time when it disappeared are displayed and stored. If the voltage drop influences a PFU 2000 only, it is displayed in the PMU 2000 as a communication fault.

## 8. Maintenance

### 8.1 Maintenance of Booster Set

#### 8.1.1 Pumps



Before starting work on the pumps, make sure that the electricity supply has been switched off and that it cannot be accidentally switched on.

Pump bearings and shaft seal are maintenance-free.

If the pump is to be drained for a long period of inactivity, remove one of the coupling guards to inject a few drops of silicone oil on the shaft between the pump head and the coupling. This will prevent the shaft seal faces from sticking.

#### 8.1.2 Motor Bearings

Motors which are not fitted with grease nipples are maintenance-free.

Motors fitted with grease nipples should be lubricated with a high-temperature lithium-based grease, see the instructions on the fan cover of GRUNDFOS motors.

In the case of seasonal operation (motor is idle for more than 6 months of the year), it is recommended to grease the motor when the pump is taken out of operation.

#### 8.1.3 Frost Protection

Pumps which are not being used during periods of frost should be drained to avoid damage.

Drain the pump by loosening the vent screw in the pump head and by removing the drain plug from the base.



Care must be taken to ensure that the escaping water does not cause injury to persons or damage to the motor or other components. In hot water installations, special attention should be paid to the risk of injury caused by scalding hot water.

Do not tighten the vent screw and replace the drain plug until the pump is to be used again.

### 8.2 Maintenance of the Control 2000 S

The Control 2000 S is maintenance-free. It must be kept clean and dry.

























## 9. Operating and Fault Indications

The two indicator lights (LED) on the front cover of PFU 2000/PMU 2000 indicate pump operation (green) and/or fault (red).

Two external indicator lights (LED) can be connected instead of the two indicator lights (LED) on the front cover.

The function of the indicator lights (LED) and the operating and fault signal outputs appears from the table below.

The fault signal relay of the PMU 2000 will be deactivated for 15 minutes if any button has been pressed during the actual fault condition and if "alarm suppression" "on" is selected (display 104).

Indicator Lights		Outputs PFU 2000		Outputs PMU 2000		Description
Fault (red)	Operation (green)	Fault	Operation	Fault	Operation	
Off	Off					Electricity supply switched off or supply failure.
Off	Permanently on					At least one pump in each zone is in operation.
Off	Flashing					All pumps in at least one zone have been stopped: <ul style="list-style-type: none"> <li>· via external on/off switch or via function selector in PFU 2000 (pos. STOP),</li> <li>· via PFU 2000/PMU 2000.</li> </ul>
Permanently on	Off					At least one pump is stopped due to fault.
Permanently on	Permanently on					At least one pump is or has been stopped due to fault. At least one pump in each zone is in operation.
Permanently on	Flashing					All pumps in at least one zone have been stopped: <ul style="list-style-type: none"> <li>· via external on/off switch or via function selector in PFU 2000 (pos. STOP),</li> <li>· via PFU 2000/PMU 2000.</li> </ul> At least one pump is or has been stopped due to fault.

## 10. Fault Finding Chart



Before making any connections in pumps, terminal boxes or controllers, the electricity supply must be switched off.

Fault	Cause	Remedy
1. Motor does not run when started.	a) Electricity supply disconnected.	Connect the electricity supply.
	b) Automatic circuit breakers cut out.	Correct the fault and cut in the automatic circuit breakers.
	c) Motor protection activated.	Correct the fault and reactivate the motor protection.
	d) Fuse in the PFU 2000 defective.	Replace the fuse.
	e) Motor defective.	Repair/replace the motor.
2. Motor starts, but stops immediately afterwards.	a) Fault in pressure transmitter.	Replace the pressure transmitter. Transmitters with 0-20 mA or 4-20 mA output signals are monitored by the PFU 2000.
	b) Dry running or no pre-pressure. The operating pressure is not reached.	Check the supply of water to the pump. When the pre-pressure has been reestablished, the pump will restart after 15 secs. and the fault indication will remain.
3. Unstable water delivery from Hydro 2000 S (applies only to very low consumption).	a) Pre-pressure too low.	Check the suction pipe and possible suction strainer.
	b) Suction pipe/pumps partly blocked by impurities.	Clean the suction pipe/pumps.
	c) Pumps suck air.	Check the suction pipe for leakages.
	d) Pressure transmitter defective.	Replace the transmitter.
4. Pumps are running, but deliver no water.	a) Suction pipe/pumps blocked by impurities.	Clean the suction pipe/pumps.
	b) Non-return valve blocked in closed position.	Clean the non-return valve. The non-return valve must move freely.
	c) Suction pipe leaky.	Check the suction pipe for leakages.
	d) Air in suction pipe/pumps.	Vent the pumps. Check the suction pipe for leakages.
	e) Motors running with the wrong direction of rotation.	Change the direction of rotation.
5. Leakage from the shaft seal.	a) Shaft seal defective.	Replace the shaft seal.
	b) Height adjustment of pump shaft inaccurate.	Readjust the shaft height.
6. Noise.	a) The pumps are cavitating.	Clean the suction pipe/pumps and possibly the suction strainer.
	b) The pumps do not rotate freely (frictional resistance) due to inaccurate height adjustment of the pump shaft.	Readjust the shaft height.
7. Very frequent starts and stops.	a) Wrong diaphragm tank precharge pressure.	Check the diaphragm tank precharge pressure.

# 11. Technical Data

## 11.1 Hydraulic Data

### Minimum Pre-Pressure:

The minimum pre-pressure “H” in metres head required to avoid cavitation in the pumps is calculated as follows:

$$H = p_b \times 10.2 - \text{NPSH} - H_f - H_v - H_s$$

$p_b$  = Barometric pressure in bar.

Barometric pressure can be set to 1 bar.

**NPSH** = **Net Positive Suction Head** in metres head  
(to be read from the NPSH curve at the highest flow).  
See Installation and Operating Instructions for CR pumps.

$H_f$  = Friction loss in suction pipe in metres head.

$H_v$  = Vapour pressure in metres head,  $t_m$  = liquid temperature.

See Installation and Operating Instructions for CR pumps.

$H_s$  = Safety margin of minimum 0.5 metres head.

**Note:** During operation, pressure drops in the manifold will increase the required minimum pre-pressure.

### Maximum Pre-Pressure:

See Installation and Operating Instructions for CR pumps.

## 11.2 Operating Conditions

**Liquid Temperature:** Maximum +70°C.

**Ambient Temperature:** 0°C to +40°C.

**Operating Pressure:** Maximum 16 bar.

## 11.3 Sound Pressure Level

For sound pressure level, see Installation and Operating Instructions for the CR pumps.

The sound pressure level for a number of pumps can be calculated as follows:

$$L_{\text{max.}} = L_{\text{pump}} + (n - 1) \times 3$$

$L_{\text{max.}}$  = Maximum sound pressure level.

$L_{\text{pump}}$  = Sound pressure level for one pump.

$n$  = Number of pumps.

## 11.4 Electrical Data

Terminal Designation or Number	Function PFU 2000	Technical Data
L, N, PE	Voltage supply for PFU 2000.	1 x 230-240 V +6% /-10%, 50 Hz, PE.
A, Y, B	Communication among the units in the GRUNDFOS Pump Management System 2000.	GRUNDFOS BUS. RS-485, GRUNDFOS BUS protocol.
1 - 4	Analog/digital input for motor protection. Motors 1, 2, 3, 4.	PTC or thermal switch (NC). PTC according to DIN 44081 or 44082.
5	Monitoring of frequency converter.	NC contact.
6	Analog control signal for frequency converter.	DC 0-10 V.
7	Connection of external LED (fault).	Positive (anode), maximum 5 mA.
8	Connection of external LED (operation).	Positive (anode), maximum 5 mA.
11 and 13	DC 24 V supply for transmitter.	Maximum 70 mA.
12	<b>Analog input 1:</b> Actual value in the system. <b>Note:</b> In systems <b>without</b> PMU 2000, pressure transmitters with the following possible signal values are typically used: 0-10 V, 0-20 mA and 4-20 mA. In systems <b>with</b> PMU 2000, pressure, differential-pressure or temperature transmitters can be used.	0-10 V. 0-20 mA. 4-20 mA. <b>NTC 50:</b> Measuring range: -25°C to +50°C. Resistance value at 25°C: 30 kΩ. <b>NTC 150:</b> Measuring range: 0°C to +150°C. Resistance value at 25°C: 100 kΩ.
14	<b>Analog input 2:</b> Input for pressure, pre-pressure, flow-pipe and return-pipe temperature measuring. <b>Note:</b> In all systems <b>without</b> PMU 2000, this input is always used for pre-pressure measuring. Input signal can be inverted by means of the DIP 1 contact 4.	0-10 V. 0-20 mA. 4-20 mA. On/off contact (digital). <b>NTC 50:</b> Measuring range: -25°C to +50°C. Resistance value at 25°C: 30 kΩ. <b>NTC 150:</b> Measuring range: 0°C to +150°C. Resistance value at 25°C: 100 kΩ.
15	<b>Analog input 3:</b> Signal for remote setting of setpoint. <b>Note:</b> In systems <b>without</b> PMU 2000, only DC 0-10 V can be used.	DC 0-10 V. 0-20 mA. 4-20 mA.
16	<b>Digital input 4:</b> (Without PMU 2000) For pressure boosting and water supply applications, input 4 is laid out for a flow switch. For heating, air-conditioning and ventilation systems, input 4 is laid out for an external on/off switch.	Maximum contact load: 12 V / 12 mA.
17	Connection of external reset button, for instance in the front cover of the control cabinet, or external potentiometer for the setting of setpoint.	Maximum contact load: 12 V / 12 mA.
20 and 30	Contact coil voltage.	
29	Frequency converter on/off.	
21, 22, 23, 24	On/off of motors 1, 2, 3, 4. Mains operation.	Maximum contact load: 250 V / 8 A, AC1.
25, 26, 27, 28	On/off of motors 1, 2, 3, 4. Frequency converter operation.	Maximum contact load: 250 V / 8 A, AC1.
31 - 33	Fault signal relay.	Potential-free changeover contacts. Maximum contact load: 250 V / 0.5 A, AC1.
41 - 43	Operating signal relay.	Potential-free changeover contacts. Maximum contact load: 250 V / 0.5 A, AC1.
Terminal Designation or Number	Function PMU 2000	Technical Data
L, N, PE	Voltage supply for PMU 2000.	1 x 230-240 V +6% /-10%, 50 Hz, PE.
1, 2, 3	Operating signal relay.	Potential-free changeover contacts. Maximum contact load: 250 V / 1.0 A, AC1.
4, 5, 6	Fault signal relay.	Potential-free changeover contacts. Maximum contact load: 250 V / 1.0 A, AC1.
7, 8, 9	Communication among the units in the GRUNDFOS Pump Management System 2000.	GRUNDFOS BUS. RS-485, GRUNDFOS BUS protocol.

## 12. Glossary

### Actual value

Actual value is the measured value.

### Analog input

Analog signals from transmitters can be connected to the analog inputs of PFU 2000 or PCU 2000.

### BUS

The GRUNDFOS BUS enables communication among the units connected to the GRUNDFOS Pump Management System 2000. The communication (RS-485) is performed according to the GRUNDFOS BUS protocol.

### Closed-loop control

Closed loop is the designation of a control system with a feedback signal from a transmitter.

### Control

The controller compares a signal from an external transmitter (actual value) with a setpoint.

The setpoint is an indication of a required state. The transmitter constantly registers whether this required state is maintained. On the basis of the above-mentioned comparison, the controller continuously adapts pump speed so as to automatically make system performance result in the required state.

### Default value

The default value is the factory-set value/parameter, i.e. the value/parameter which will appear if no other value is set. This is for instance the case in connection with presettings.

### Differential pressure

Differential pressure is the pressure difference between two measuring points, e.g. between suction and discharge ports of the pump.

### Differential temperature

Differential temperature is the temperature difference between two measuring points, e.g. flow and return pipes.

### Digital input

Digital signals from signal transmitters can be connected to the digital inputs of the PFU 2000.

### Display overview

A display overview is a total overview of the displays which may appear in a menu with a given presetting.

### Flow

Flow is the quantity of pumped liquid which passes through pumps/a zone within a certain period, e.g. indicated in [m<sup>3</sup>/h].

### Head

Head designates the pressure increase imparted to the liquid by the pump, e.g. indicated in [m].

### “Local” operation

When the pumps/zone are not controlled via a PMU 2000 but according to the settings made via the PFU 2000, the operating mode is referred to as “local”.

### “Max.” operation

When the pumps/zone are controlled via a PMU 2000 or via the PFU 2000, it is possible to set the pumps/zone to “Max.” operation. The pumps will run at maximum speed (irrespective of external signals).

### Menu

Menu is the designation of one of six different groups of displays in the PMU 2000. Settings and readings are made in the menus, which consist of a number of displays.

### Open-loop control

Open loop is the designation of a control system without feedback signal from a transmitter.

### PCU 2000

The Pump Communication Unit 2000 is used for communication between the GRUNDFOS BUS and external control and monitoring systems.

### PFU 2000

The Pump Functional Unit 2000 is used to control and monitor pumping systems.

### PMU 2000

The Pump Management Unit 2000 is used to monitor and optimize pumping systems.

### Pre-pressure

Pre-pressure is the pressure which can be measured immediately before the booster set/pump.

### Progressive pressure

Progressive pressure means that the pressure in the system rises/falls proportionally to the flow (friction loss compensation).

### Proportional pressure

See “Progressive pressure”.

### Temperature influence

Temperature influence means that the setpoint is influenced by the actual liquid temperature. The liquid temperature is continuously measured and the setpoint automatically adjusted according to this measurement and a setpoint influence table.

### Zone

A zone is a closed hydraulic system in which all pumps have common suction and discharge pipes.



# 13. Display Overviews

The following shows the display overviews for the PMU 2000, including the basic menu and the display overviews for zone type PFU and the control parameters "pressure" and "pressure with pre-pressure measuring".

The displays with double lines are only available on service code level.

By pressing "Esc" repeatedly, you can always return to display 100.

## Basic Menu

100	Status 1.2.3.4 5 6 7 8 I I 0 A M - -
101	Configuration 12345678 set to zone AAC
102	Configuration presetting →
103	Configuration Mon clock 11:07 h 21-07-94
104	Configuration alarm suppression on
105	Configuration pump comm. alarm on
106	Configuration PMU GRUNDFOS 00620194/9420
107	Configuration PCU GRUNDFOS 00610194/9420
108	Configuration PFU GRUNDFOS 00630194/9420
	Configuration <<< End of menu >>>

111	Zone A 12 UPE 1 head
	Zone A 12 UPE 2 head
	Zone A 12 UPE 3 op.loop
	Zone A 12 PFU 1 diffpr.
	Zone A 12 PFU 2 tempdif
	Zone A 12 PFU 3 temp.
	Zone A 12 PFU 4 flow
	Zone A 12 PFU 5 level
	Zone A 12 PFU 6 op.loop.
	Zone A 12 PFU 7 press.
	Zone A 12 PFU 8 press.

TM00 5353 0695

**PFU 7: Pressure**

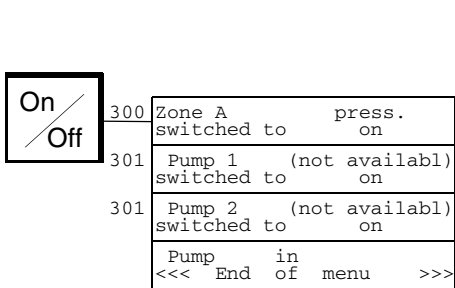
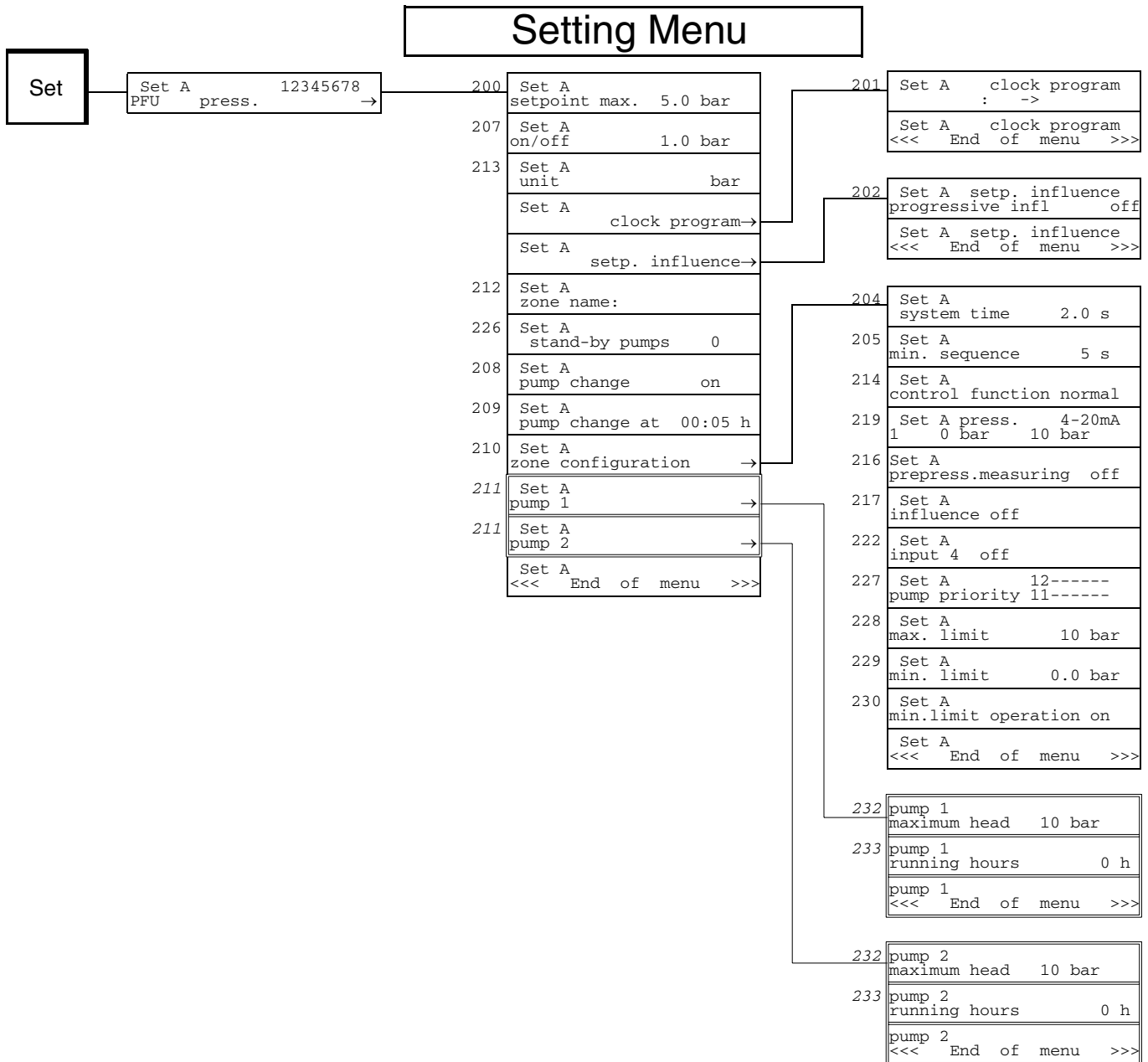

## Zone Status Menu

Zone status

Zone A press. 12 →

```

401 Zone A setpoint act. 5.0 bar →
403 Zone A actual value 0.0 bar
404 Zone A speed 0 %max. 0
405 Zone A setpoint max. 5.0 bar
407 Zone A on/off 0.0 bar
      Zone A clock program →
421 Zone A stand-by pumps 0
410 Zone A pump change on
411 Zone A pump change at 00:05 h
210 Zone A zone configuration →
      Zone A
      <<< End of menu >>>
    
```

```

402 Zone A setp. influence setpoint max. 5.0 bar
      Zone A setp. influence remote → 5.0 bar
      Zone A setp. influence setpoint act. 5.0 bar
      Zone A setp. influence <<< End of menu >>>
    
```

```

406 Zone A clock program <<< End of menu >>>
    
```

```

408 Zone A system time 2.0 s
409 Zone A min. sequence 5 s
412 Zone A control function normal
416 Zone A press. 4-20mA 1 0 bar 10 bar
414 Zone A prepress.measuring off
415 Zone A influence off
419 Zone A input 4 off
422 Zone A 12----- pump priority 11-----
423 Zone A max. limit 10 bar
424 Zone A min. limit 0.0 bar
425 Zone A min.limit operation on
      Zone A
      <<< End of menu >>>
    
```

## Pump Status Menu

Pump status

```

500 Pump 1 in A (not availabl) →
500 Pump 2 in A (not availabl) →
      Pump in <<< End of menu >>>
    
```

```

504 pump 1 (not availabl) maximum head 10 bar
508 pump 1 (not availabl) running hours 0 h
      pump 1 (not availabl) <<< End of menu >>>
    
```

```

504 pump 2 (not availabl) maximum head 10 bar
508 pump 2 (not availabl) running hours 0 h
      pump 2 (not availabl) <<< End of menu >>>
    
```

## Fault Indication Menu

Alarm status

```

600 Alarm 1
      Alarm 2
    
```

**PFU 8: Pressure with Pre-Pressure Measuring**

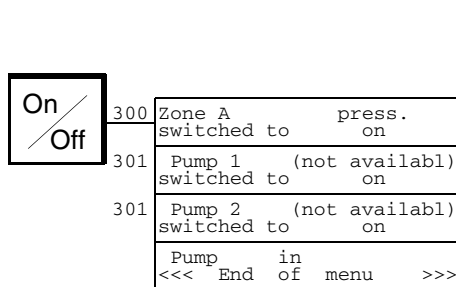
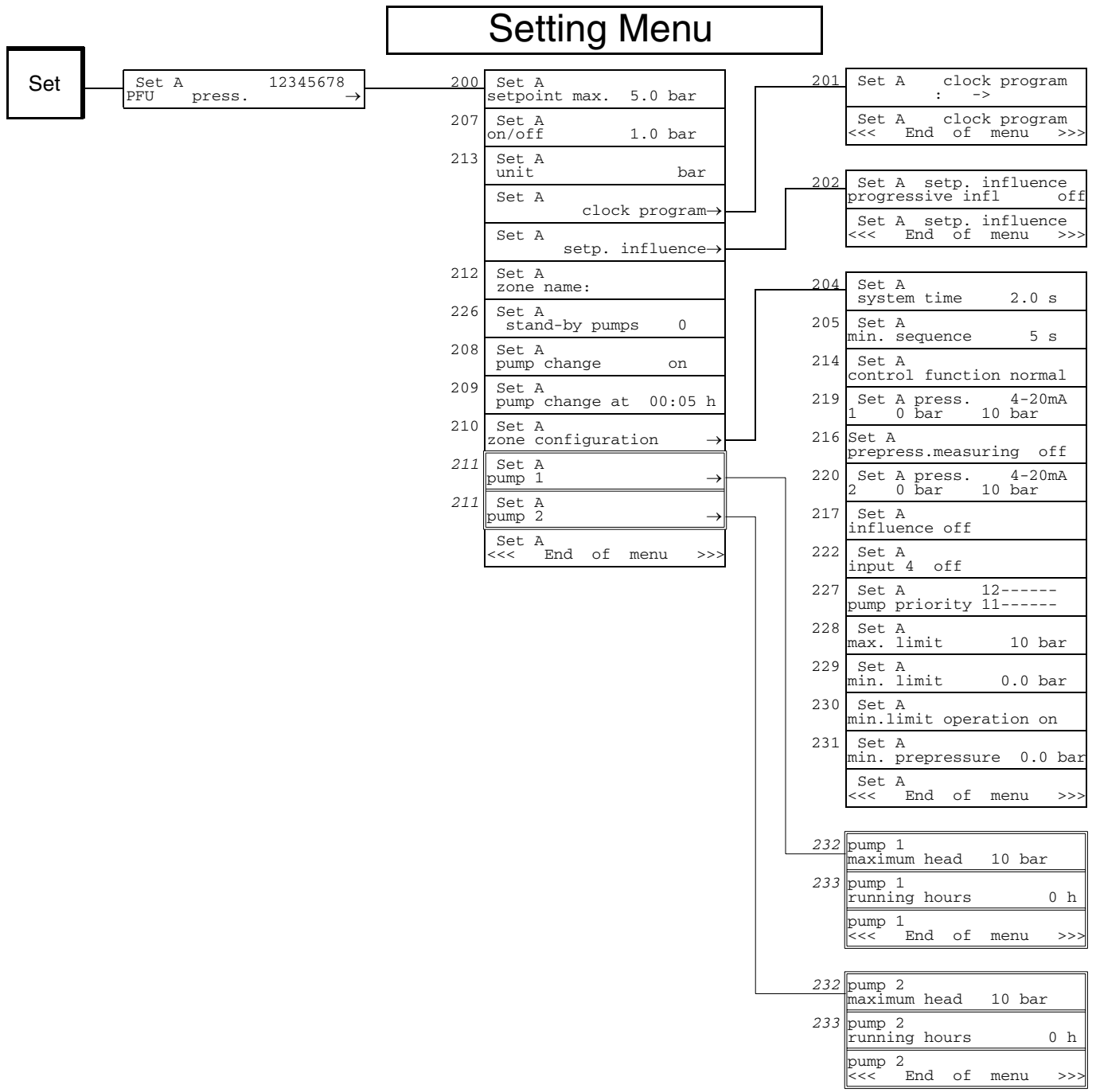

TM00 5352 0695

# Zone Status Menu

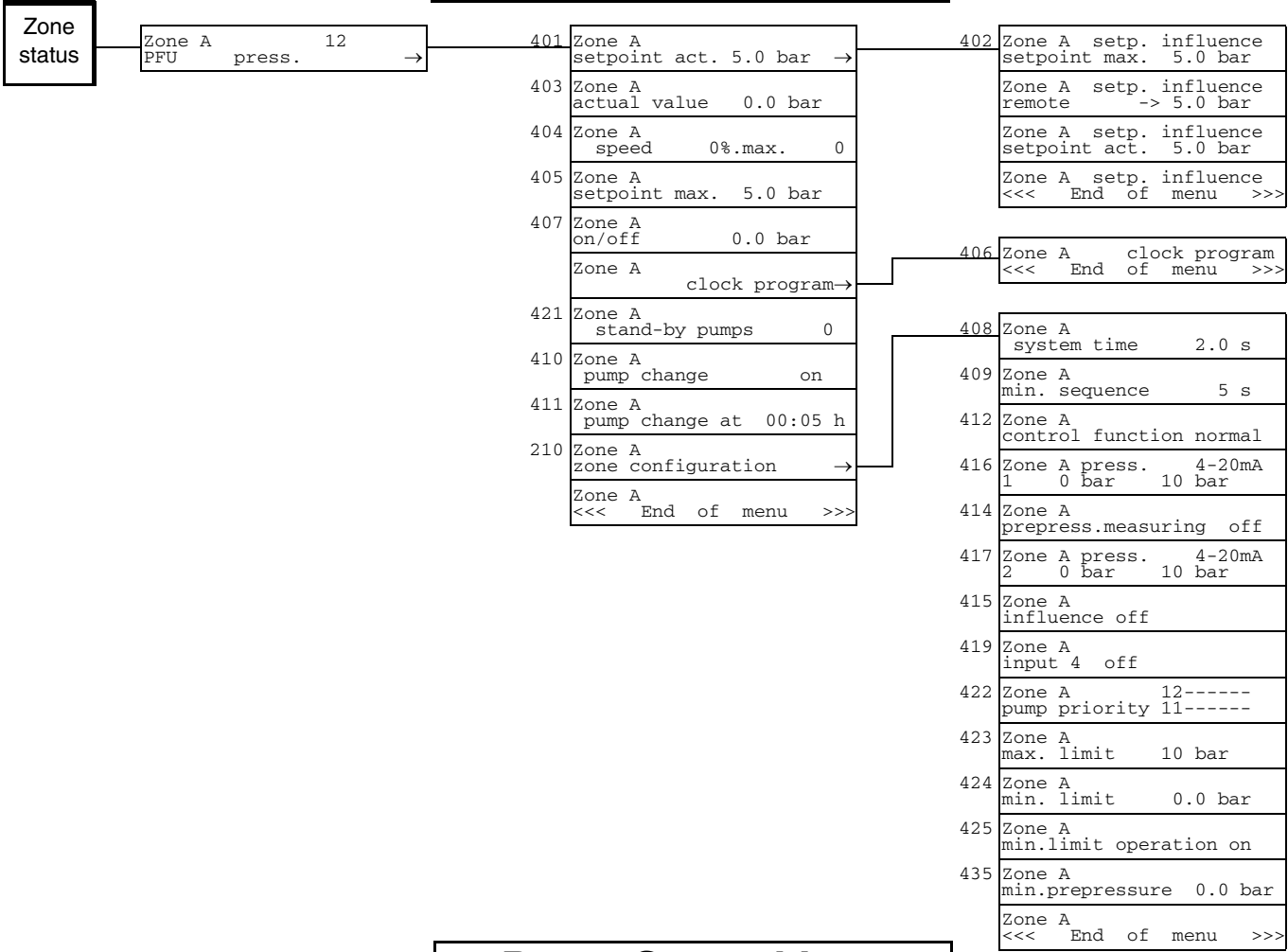

# Pump Status Menu

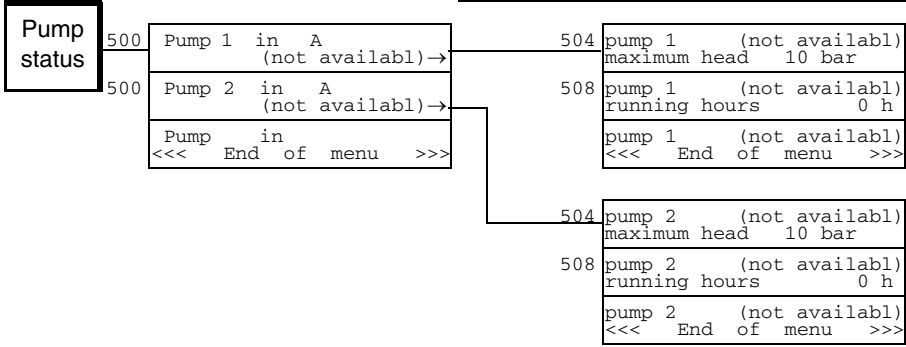

# Fault Indication Menu

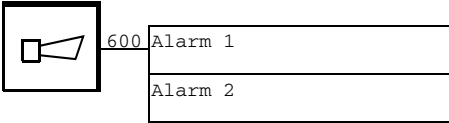

**Denmark**

GRUNDFOS DK A/S  
Poul Due Jensens Vej 7A  
DK-8850 Bjerringbro  
Tlf.: +45-87 50 50 50  
Telefax: +45-87 50 51 51

**Argentina**

Bombas GRUNDFOS de Argentina S.A.  
Ruta Panamericana km. 37.500 Lote 34A  
1619 - Garin  
Pcia. de Buenos Aires  
Phone: +54-3327 414 444  
Telefax: +54-3327 411 111

**Australia**

GRUNDFOS Pumps Pty. Ltd.  
P.O. Box 2040  
Regency Park  
South Australia 5942  
Phone: +61-8-8461-4611  
Telefax: +61-8-8340 0155

**Austria**

GRUNDFOS Pumpen Vertrieb Ges.m.b.H.  
Grundfosstraße 2  
A-5082 Grödig/Salzburg  
Tel.: +43-6246-883-0  
Telefax: +43-6246-883-30

**Belgium**

N.V. GRUNDFOS Bellux S.A.  
Boomsesteenweg 81-83  
B-2630 Aartselaar  
Tél.: +32-3-870 7300  
Télécopie: +32-3-870 7301

**Brazil**

GRUNDFOS do Brasil Ltda.  
Rua Tomazina 106  
CEP 83325 - 040  
Pinhais - PR  
Phone: +55-41 668 3555  
Telefax: +55-41 668 3554

**Canada**

GRUNDFOS Canada Inc.  
2941 Brighton Road  
Oakville, Ontario  
L6H 6C9  
Phone: +1-905 829 9533  
Telefax: +1-905 829 9512

**China**

GRUNDFOS Pumps (Shanghai) Co. Ltd.  
22 Floor, Xin Hua Lian Building  
755-775 Huai Hai Rd, (M)  
Shanghai 200020  
PRC  
Phone: +86-512-67 61 11 80  
Telefax: +86-512-67 61 81 67

**Czech Republic**

GRUNDFOS s.r.o.  
Cajkovského 21  
779 00 Olomouc  
Phone: +420-68-5716 111  
Telefax: +420-68-543 8908

**Finland**

OY GRUNDFOS Pumput AB  
Mestarintie 11  
Piispankylä  
FIN-01730 Vantaa (Helsinki)  
Phone: +358-9 878 9150  
Telefax: +358-9 878 91550

**France**

Pompes GRUNDFOS Distribution S.A.  
Parc d'Activités de Chesnes  
57, rue de Malacombe  
F-38290 St. Quentin Fallavier (Lyon)  
Tél.: +33-4 74 82 15 15  
Télécopie: +33-4 74 94 10 51

**Germany**

GRUNDFOS GMBH  
Schlüterstr. 33  
40699 Erkrath  
Tel.: +49-(0) 211 929 69-0  
Telefax: +49-(0) 211 929 69-3799  
e-mail: infoservice@grundfos.de  
Service in Deutschland:  
e-mail: kundendienst@grundfos.de

**Greece**

GRUNDFOS Hellas A.E.B.E.  
20th km. Athinon-Markopoulou Av.  
P.O. Box 71  
GR-19002 Peania  
Phone: +0030-210-66 83 400  
Telefax: +0030-210-66 46 273

**Hong Kong**

GRUNDFOS Pumps (Hong Kong) Ltd.  
Unit 1, Ground floor  
Siu Wai Industrial Centre  
29-33 Wing Hong Street &  
68 King Lam Street, Cheung Sha Wan  
Kowloon  
Phone: +852-27861706/27861741  
Telefax: +852-27858664

**Hungary**

GRUNDFOS Hungária Kft.  
Park u. 8  
H-2045 Törökbalint,  
Phone: +36-34 520 100  
Telefax: +36-34 520 200

**India**

GRUNDFOS Pumps India Private Limited  
Flat A, Ground Floor  
61/62 Chamiers Aptmt  
Chamiers Road  
Chennai 600 028  
Phone: +91-44 432 3487  
Telefax: +91-44 432 3489

**Indonesia**

PT GRUNDFOS Pompa  
Jl. Rawa Sumur III, Blok III / CC-1  
Kawasan Industri, Pulogadung  
Jakarta 13930  
Phone: +62-21-460 6909  
Telefax: +62-21-460 6910/460 6901

**Ireland**

GRUNDFOS (Ireland) Ltd.  
Unit 34, Stillorgan Industrial Park  
Blackrock  
County Dublin  
Phone: +353-1-2954926  
Telefax: +353-1-2954739

**Italy**

GRUNDFOS Pompe Italia S.r.l.  
Via Gran Sasso 4  
I-20060 Truccazzano (Milano)  
Tel.: +39-02-95838112  
Telefax: +39-02-95309290/95838461

**Japan**

GRUNDFOS Pumps K.K.  
1-2-3, Shin Miyakoda  
Hamamatsu City  
Shizuoka pref. 431-21  
Phone: +81-53-428 4760  
Telefax: +81-53-484 1014

**Korea**

GRUNDFOS Pumps Korea Ltd.  
2nd Fl., Dong Shin Building  
994-3 Daechi-dong, Kangnam-Ku  
Seoul 135-280  
Phone: +82-2-5317 600  
Telefax: +82-2-5633 725

**Malaysia**

GRUNDFOS Pumps Sdn. Bhd.  
7 Jalan Peguam U1/25  
Glenmarie Industrial Park  
40150 Shah Alam  
Selangor  
Phone: +60-3-5569 2922  
Telefax: +60-3-5569 2866

**Mexico**

Bombas GRUNDFOS de Mexico S.A. de C.V.  
Boulevard TLC No. 15  
Parque Industrial Stiva Aeropuerto  
Apodaca, N.L. 66600  
Mexico  
Phone: +52-81-8144 4000  
Telefax: +52-81-8144 4010

**Netherlands**

GRUNDFOS Nederland B.V.  
Postbus 104  
NL-1380 AC Weesp  
Tel.: +31-294-492 211  
Telefax: +31-294-492244/492299

**New Zealand**

GRUNDFOS Pumps NZ Ltd.  
17 Beatrice Tinsley Crescent  
North Harbour Industrial Estate  
Albany, Auckland  
Phone: +64-9-415 3240  
Telefax: +64-9-415 3250

**Norway**

GRUNDFOS Pumper A/S  
Strømsveien 344  
Postboks 235, Leirdal  
N-1011 Oslo  
Tlf.: +47-22 90 47 00  
Telefax: +47-22 32 21 50

**Poland**

GRUNDFOS Pompy Sp. z o.o.  
ul. Klonowa 23  
Baranowo k. Poznania  
PL-62-081 Przemierowo  
Phone: +48-61-650 13 00  
Telefax: +48-61-650 13 50

**Portugal**

Bombas GRUNDFOS Portugal, S.A.  
Rua Calvet de Magalhães, 241  
Apartado 1079  
P-2780 Paço de Arcos  
Tel.: +351-21-440 76 00  
Telefax: +351-21-440 76 90

**Russia**

OOO GRUNDFOS  
Shkolnaya 39  
RUS-109544 Moscow  
Phone: +7-095 564 88 00, +7-095 737 30 00  
Telefax: +7-095 564 88 11, +7-095 737 75 36  
e-mail: grundfos.moscow@grundfos.com

**Singapore**

GRUNDFOS (Singapore) Pte. Ltd.  
24 Tuas West Road  
Jurong Town  
Singapore 638381  
Phone: +65-6865 1222  
Telefax: +65-6861 8402

**Spain**

Bombas GRUNDFOS España S.A.  
Camino de la Fuentesilla, s/n  
E-28110 Algete (Madrid)  
Tel.: +34-91-848 8800  
Telefax: +34-91-628 0465

**Sweden**

GRUNDFOS AB  
Box 63, Angeredsvinkeln 9  
S-424 22 Angered  
Tel.: +46-771-32 23 00  
Telefax: +46-31 331 94 60

**Switzerland**

GRUNDFOS Pumpen AG  
Bruggacherstrasse 10  
CH-8117 Fällanden/ZH  
Tel.: +41-1-806 8111  
Telefax: +41-1-806 8115

**Taiwan**

GRUNDFOS Pumps (Taiwan) Ltd.  
14, Min-Yu Road  
Tunglo Industrial Park  
Tunglo, Miao-Li County  
Taiwan, R.O.C.  
Phone: +886-37-98 05 57  
Telefax: +886-37-98 05 70

**Thailand**

GRUNDFOS (Thailand) Ltd.  
947/168 Moo 12, Bangna-Trad Rd., K.M. 3,  
Bangna, Phrakonong  
Bangkok 10260  
Phone: +66-2-744 1785 ... 91  
Telefax: +66-2-744 1775 ... 6

**Turkey**

GRUNDFOS POMPA SAN. ve TIC. LTD. STI  
Bulgurlu Caddesi no. 32  
TR-81190 Üsküdar Istanbul  
Phone: +90 - 216-4280 306  
Telefax: +90 - 216-3279 988

**United Arab Emirates**

GRUNDFOS Gulf Distribution  
P.O. Box 16768  
Jebel Ali Free Zone  
Dubai  
Phone: +971-4- 8815 166  
Telefax: +971-4-8815 136

**United Kingdom**

GRUNDFOS Pumps Ltd.  
Grovebury Road  
Leighton Buzzard/Beds. LU7 8TL  
Phone: +44-1525-850000  
Telefax: +44-1525-850011

**U.S.A.**

GRUNDFOS Pumps Corporation  
17100 West 118th Terrace  
Olathe, Kansas 66061  
Phone: +1-913-227-3400  
Telefax: +1-913-227-3500

96 40 69 13 1202	GB
Repl. V7 12 16 26 0299	